

Pilot's Operating Handbook And Flight Training Supplement

SKYCATCHER



Model 162

Serials 16200001 and On

SERIAL NUMBER _____

REGISTRATION NUMBER _____

This publication includes the material required to be furnished to the pilot by ASTM F2245.

**PILOT'S OPERATING HANDBOOK
AND
FLIGHT TRAINING SUPPLEMENT**

CESSNA MODEL 162

**SERIALS
16200001 AND ON**

ORIGINAL ISSUE - 22 JULY 2009

REVISION 2 - 26 APRIL 2010

PART NUMBER: 162PHUS-02

CONGRATULATIONS

Congratulations on your purchase and welcome to Cessna ownership! Your Cessna has been designed and constructed to give you the most in performance, value and comfort.

This Pilot's Operating Handbook has been prepared as a guide to help you get the most utility from your airplane. It contains information about your airplane's equipment, operating procedures, performance and suggested service and care. Please study it carefully and use it as a reference.

The worldwide Cessna Organization and Cessna Customer Service are prepared to serve you. The following services are offered by each Cessna Service Station:

- THE CESSNA AIRPLANE WARRANTIES, which provide coverage for parts and labor, are upheld through Cessna Service Stations worldwide. Warranty provisions and other important information are contained in the Customer Care Handbook supplied with your airplane. The Customer Care Card assigned to you at delivery will establish your eligibility under warranty and should be presented to your local Cessna Service Station at the time of warranty service.
- FACTORY TRAINED PERSONNEL to provide you with courteous, expert service.
- FACTORY APPROVED SERVICE EQUIPMENT to provide you efficient and accurate workmanship.
- A STOCK OF GENUINE CESSNA SERVICE PARTS are available when you need them.
- THE LATEST AUTHORITATIVE INFORMATION FOR SERVICING CESSNA AIRPLANES. Cessna Service Stations have all of the current Maintenance Manuals, Illustrated Parts Catalogs and various other support publications produced by Cessna Aircraft Company.

A Cessna Service Station locator is available at www.cessnasupport.com.

We urge all Cessna owners/operators to utilize the benefits available within the Cessna Organization.

PERFORMANCE - SPECIFICATIONS***SPEED:**

Maximum at Sea Level 118 KNOTS (218.5 km/hr)
Cruise, 69% Power at 6000 Feet. 109 KNOTS (201.9 km/hr)

CRUISE: Recommended lean mixture with fuel allowance for engine start, taxi, takeoff, climb and 30 minutes reserve.

RANGE:

69% Power at 6000 Feet Range - 360 NM
24 Gallons Usable Fuel Time - 3.30 HOURS

RATE OF CLIMB AT SEA LEVEL 880 FPM (268.2 mpm)

SERVICE CEILING 14,625 FEET (4457.7 m)

TAKEOFF PERFORMANCE AT SEA LEVEL:

Ground Roll 640 FEET (195.1 m)
Total Distance Over 50 Foot Obstacle 1138 FEET (346.9 m)

LANDING PERFORMANCE AT SEA LEVEL:

Ground Roll 671 FEET (204.6 m)
Total Distance Over 50 Foot Obstacle 1369 FEET (417.3 m)

STALL SPEED:

Flaps UP, Power Idle 41 KIAS
Flaps FULL, Power Idle 37 KIAS

NOTE

* Speed performance is shown for airplanes not equipped with the optional speed fairings. Airplanes equipped with optional speed fairings will notice a increase in speeds by approximately 2 knots. There is a corresponding difference in range, while all other performance figures are unchanged when speed fairings are installed.

The above performance figures are based on airplane weights at 1320 pounds (598.7 kg), standard atmospheric conditions, level, hard-surfaced dry runways and no wind. They are calculated values derived from flight tests conducted by Cessna Aircraft Company under carefully documented conditions and will vary with individual airplanes and numerous factors affecting flight performance.

(Continued Next Page)

PERFORMANCE - SPECIFICATIONS (Continued)

MAXIMUM WEIGHT:

Ramp.	1324 POUNDS (600.5 kg)
Takeoff.	1320 POUNDS (598.7 kg)
Landing.	1320 POUNDS (598.7 kg)

STANDARD EMPTY WEIGHT. 834 POUNDS (378.3 kg)

■ MAXIMUM USEFUL LOAD 490 POUNDS (220.4 kg)

■ BAGGAGE ALLOWANCE 50 POUNDS (22.68 kg)

WING LOADING 11.0 lbs/sq. ft. (53.7 kg/sq m)

POWER LOADING 13.2 lbs/HP

FUEL CAPACITY (Usable) 24 GALLONS (90.8 l)

■ OIL CAPACITY (Sump) 5 QUARTS (4.73 l)

ENGINE: Teledyne Continental Motors O-200D
100 BHP at 2750 RPM

PROPELLER:

■ Fixed Pitch, Diameter 67 INCHES (1.70 m)

COVERAGE

The Pilot's Operating Handbook (POH) in the airplane at the time of delivery from Cessna Aircraft Company contains information applicable to the Model 162 airplanes by serial number and registration number shown on the Title Page. This POH is applicable to Model 162 airplanes, Serials 16200001 and On. All information is based on data available at the time of publication.

This POH consists of ten sections that cover all operational aspects of a standard equipped airplane. Section 10 contains the supplements which provide amended operating limitations, operating procedures, performance data and other necessary information for airplanes conducting special operations for both standard and optional equipment installed in the airplane.

Supplements are individual documents, and may be issued or revised without regard to revision dates which apply to the POH itself. These supplements contain a Log of Effective Pages, which should be used to determine the status of each supplement.

ORIGINAL ISSUE AND REVISIONS

This Pilot's Operating Handbook is comprised of the original issue and any subsequent revisions. To make sure that information in this manual is current, the revisions must be incorporated as they are issued. As revisions are issued, they will be noted in the Log of Effective Pages.

The part number of this manual has also been designed to further aid the owner/operator in determining the revision level of any POH. Refer to the example below for a breakdown:

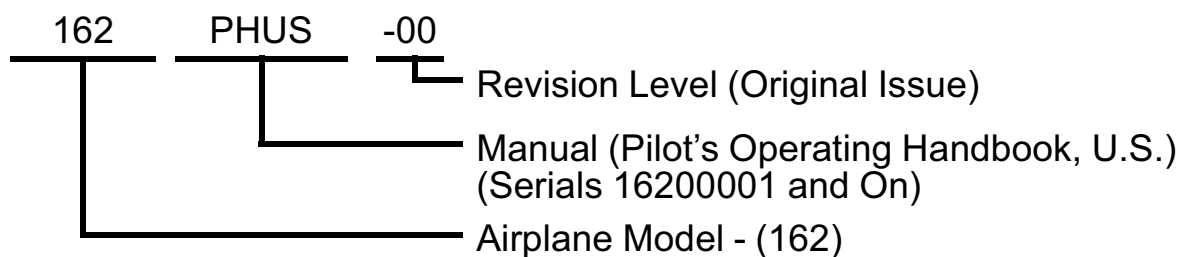

It is the responsibility of the owner to maintain this POH in a current status when it is being used for operational purposes. Owners should contact a Cessna Service Station whenever the revision status of their POH is in question.

Revisions are distributed to owners of U.S. Registered aircraft according to FAA records at the time of revision issuance, and to Internationally Registered aircraft according to Cessna Owner Advisory records at the time of issuance. Revisions should be read carefully upon receipt and incorporated in this POH.

REVISION FILING INSTRUCTIONS

REGULAR REVISIONS

Pages to be removed or inserted in the Pilots' Operating Handbook are determined by the Log of Effective Pages located in this section. This log contains the page number and revision level for each page within the POH. As revisions to the POH occur, the revision level on effected pages is updated. When two pages display the same page number, the page with the latest revision level shall be inserted into the POH. The revision level on the Log Of Effective Pages shall also agree with the revision level of the page in question.

TEMPORARY REVISIONS

Under limited circumstances, temporary revisions to the POH may be issued. These temporary revisions are to be filed in the applicable section in accordance with filing instructions appearing on the first page of the temporary revision.

Temporary Revisions will remain current until they have either been incorporated into the next POH revision or another temporary revision has been issued that supersedes that temporary revision. Each temporary revision is issued with a current List of Temporary Revisions that is to be inserted opposite the first page of the Log of Effective Pages in the front of the POH and will supersede any previously issued List of Temporary Revisions. This list is used to track the status of temporary revisions issued against this POH and is to be removed and discarded at the next revision to the POH. Removal of temporary revisions from the POH is accomplished per the removal instructions on each temporary revision.

IDENTIFYING REVISED MATERIAL

A bar will extend the full length of deleted, new, or revised text added on new or previously existing pages. This bar will be located adjacent to the applicable text in the margin on the left side of the page.

A bar in the footer will indicate a revision to the header/footer, a new page, format or spelling/grammar changes and/or that information has slipped to or from that page.

A bar located adjacent to the figure number in the margin on the left side of the page will be used to indicate that the figure number only has changed.

An asterisk located at the end of a figure number will be used to indicate that an illustration has been revised or is all new material (Ex: Figure 3-4*).

All revised pages will carry the revision number opposite the page number on the applicable page. A list of revisions is located at the beginning of the Log Of Effective Pages.

WARNINGS, CAUTIONS AND NOTES

Throughout the text, warnings, cautions and notes pertaining to airplane handling and operations are utilized. These adjuncts to the text are used to highlight or emphasize important points.

WARNING

**OPERATING PROCEDURES, TECHNIQUES, ETC.,
WHICH CAN RESULT IN PERSONAL INJURY OR LOSS
OF LIFE IF NOT CAREFULLY FOLLOWED.**

CAUTION

**OPERATION PROCEDURES, TECHNIQUES, ETC.,
WHICH CAN RESULT IN DAMAGE TO EQUIPMENT IF
NOT CAREFULLY FOLLOWED.**

NOTE

An operating procedure, technique, etc., which is considered essential to emphasize.

LOG OF EFFECTIVE PAGES

Use this page to determine the currency and applicability of your POH.

Pages affected by the current revision are indicated by an asterisk (*) preceding the pages listed under the Page Number column.

<u>Revision Level</u>	<u>Date of Issue</u>		
Original Issue	22 July 2009	Revision 2	26 April 2010
Revision 1	2 November 2009		

Page Number	Page Status	Revision Number
* Title	Revised	2
* i/ii	Revised	2
iii thru vi	Revised	1
vii thru x	Original	0
* xi thru xiv	Revised	2
xv/xvi	Added	1
1-1/1-2	Original	0
1-3 thru 1-5	Revised	1
1-6 thru 1-7	Original	0
1-8	Revised	1
2-1 thru 2-8	Revised	1
2-9 thru 2-10	Original	0
2-11 thru 2-12	Revised	1
2-13	Original	0
2-14 thru 2-25/2-26	Revised	1
3-1/3-2	Revised	1
3-3	Original	0
* 3-4	Revised	2
3-5 thru 3-6	Revised	1
3-7	Original	0

(Continued Next Page)

LOG OF EFFECTIVE PAGES (Continued)

Page Number	Page Status	Revision Number
3-8 thru 3-13	Revised	1
3-14	Original	0
3-15	Revised	1
3-16	Original	0
* 3-17	Revised	2
3-18 thru 3-19/3-20	Revised	1
4-1/4-2 thru 4-4	Original	0
4-5	Revised	1
4-6	Original	0
4-7	Revised	1
4-8	Original	0
4-9 thru 4-10	Revised	1
4-11 thru 4-14	Original	0
4-15 thru 4-16	Revised	1
4-17 thru 4-22	Original	0
4-23 thru 4-26	Revised	1
4-27 thru 4-30	Original	0
5-1/5-2	Original	0
5-3 thru 5-9	Revised	1
5-10 thru 5-11	Original	0
5-12 thru 5-16	Revised	1
5-17 thru 5-18	Original	0
6-1 thru 6-4	Original	0
* 6-5	Revised	2
6-6	Original	0
6-7 thru 6-8	Revised	1
6-9 thru 6-14	Original	0
6-15	Revised	1
6-16	Original	0
6-17 thru 6-18	Revised	1
6-19	Original	0

(Continued Next Page)

LOG OF EFFECTIVE PAGES (Continued)

Page Number	Page Status	Revision Number
6-20	Revised	1
6-21 thru 6-22	Original	0
6-23 thru 6-26	Revised	1
6-27 thru 6-30	Original	0
6-31 thru 6-33	Revised	1
6-34 thru 6-39	Original	0
6-40	Revised	1
7-1 thru 7-2	Revised	1
* 7-3	Revised	2
7-4	Original	0
7-5	Revised	1
7-6 thru 7-7	Original	0
7-8 thru 7-10	Revised	1
7-11 thru 7-12	Original	0
7-13 thru 7-16	Revised	1
7-17	Original	0
7-18 thru 7-21	Revised	1
7-22 thru 7-24	Original	0
7-25 thru 7-26	Revised	1
7-27 thru 7-29	Original	0
7-30 thru 7-41	Revised	1
7-42 thru 7-43	Original	0
7-44 thru 7-45/7-46	Revised	1
8-1	Original	0
8-2 thru 8-10	Revised	1
8-11 thru 8-12	Original	0
8-13	Revised	1
8-14 thru 8-18	Original	0
8-19 thru 8-25/8-26	Revised	1

(Continued Next Page)

LOG OF EFFECTIVE PAGES (Continued)

Page Number	Page Status	Revision Number
9-1/9-2	Original	0
9-3	Revised	1
9-4 thru 9-5	Original	0
* 9-6	Revised	2
9-7 thru 9-8	Revised	1
10-1/10-2	Original	0

TABLE OF CONTENTS

	SECTION
GENERAL	1
AIRPLANE AND SYSTEM DESCRIPTION	2
OPERATING LIMITATIONS	3
WEIGHT AND BALANCE/EQUIPMENT LIST	4
PERFORMANCE	5
EMERGENCY PROCEDURES	6
NORMAL PROCEDURES	7
AIRCRAFT HANDLING, SERVICE AND MAINTENANCE	8
PLACARDS AND MARKINGS	9
SUPPLEMENTARY INFORMATION	10

GENERAL

TABLE OF CONTENTS

	Page
Three View - Normal Ground Attitude	1-3
Introduction	1-5
Descriptive Data	1-5
Engine	1-5
Propeller	1-5
Fuel	1-6
Fuel Capacity	1-6
Oil	1-7
Oil Specification	1-7
Oil Capacity	1-7
Maximum Certificated Weights	1-8
Maximum Weight In Baggage Compartment	1-8
Standard Airplane Weights	1-8
Cabin And Entry Dimensions	1-8
Baggage Space And Entry Dimensions	1-8
Specific Loadings	1-8

THREE VIEW - NORMAL GROUND ATTITUDE

B8437

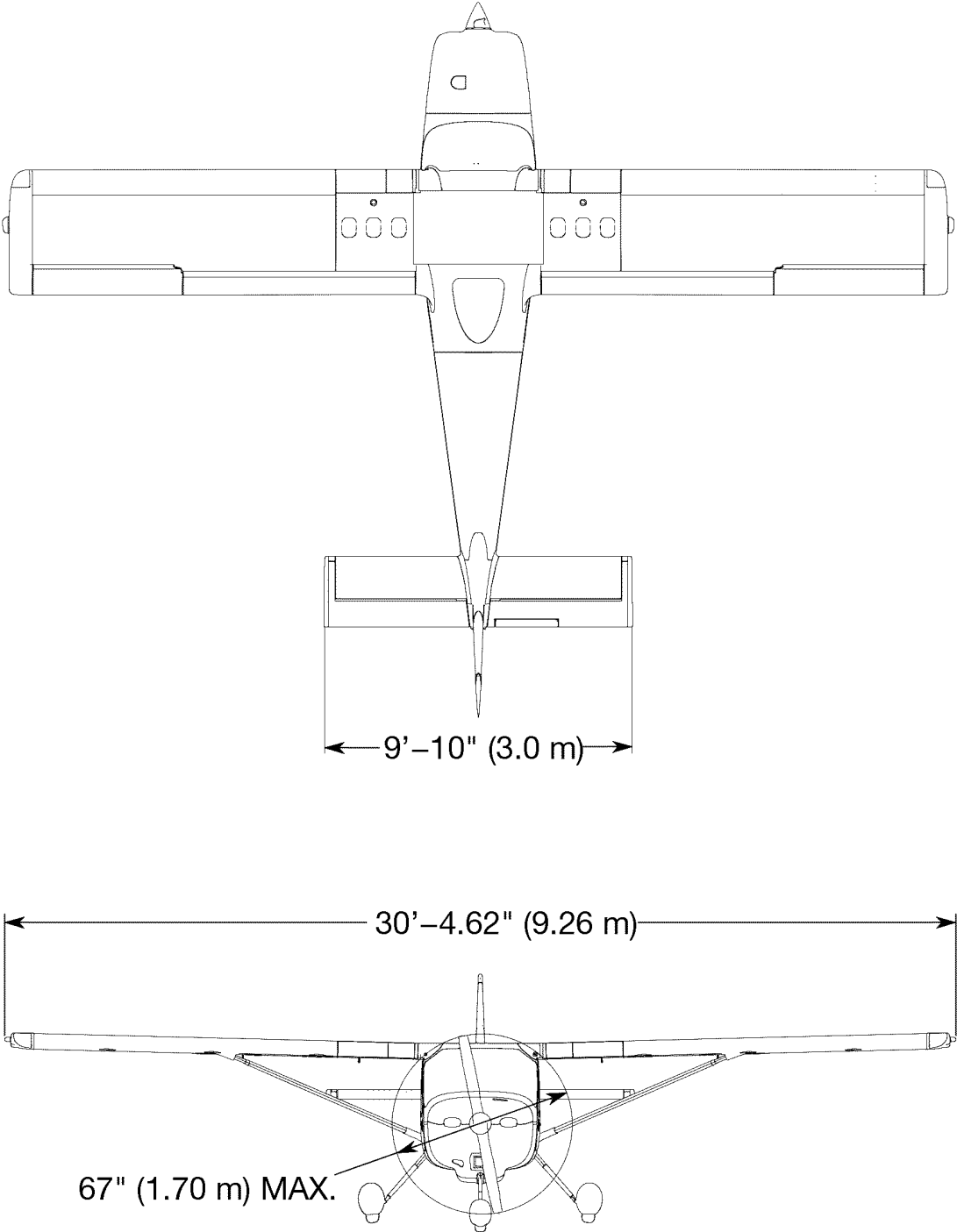

0910T1002
0910T1002

Figure 1-1* (Sheet 1 of 2)

THREE VIEW - NORMAL GROUND ATTITUDE

B8439

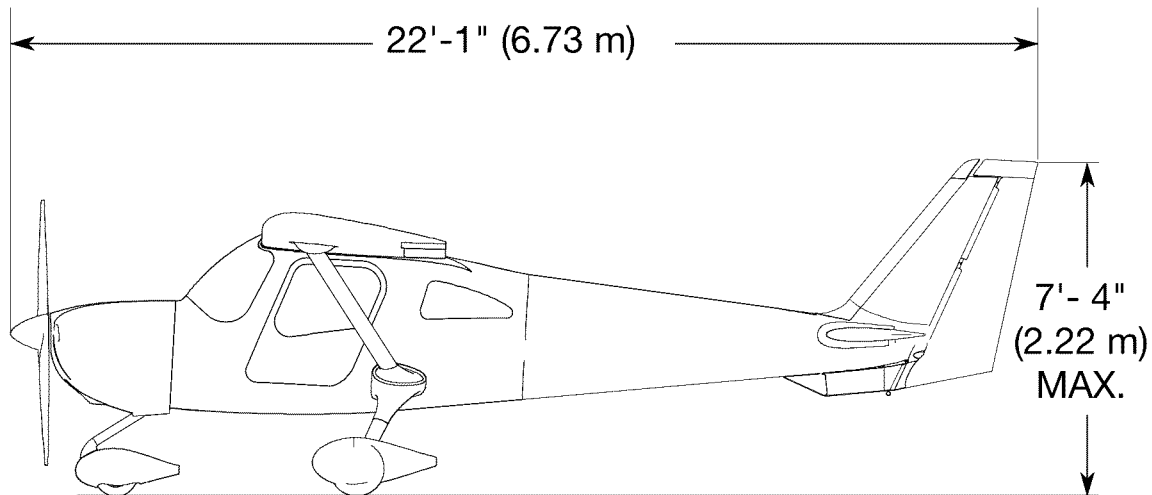

0910T1002

NOTE

- Wing span shown with standard strobe lights installed.
- Wheel base length is 62.40 inches (1.58 m).
- Propeller ground clearance is 8.50 inches (215.90 mm).
- Wing area is 120.0 square feet (11.15 sq. m).

Figure 1-1* (Sheet 2)

INTRODUCTION

This POH contains 10 sections, and includes the material required to be furnished to the pilot by American Society for Testing and Materials International (ASTM) standards F2245 for Light Sport Aircraft (LSA). It also contains supplemental data supplied by Cessna Aircraft Company.

Section 1 provides basic data and information of general interest.

DESCRIPTIVE DATA

ENGINE

Number of Engines: 1

Engine Manufacturer: Teledyne Continental Motors

Engine Model Number: O-200-D

Engine Type: Normally aspirated, direct drive, air-cooled, horizontally opposed, carburetor equipped, four cylinder engine with 201.0 cu. in. displacement.

Horsepower Rating and Engine Speed: 100 rated BHP at 2750 RPM

PROPELLER

Propeller Manufacturer: McCauley Propeller Systems

Propeller Model Number: 1A162/TCD6754

Number of Blades: 2

Propeller Diameter: 67 inches (1.70 m)

Propeller Type: Fixed Pitch

(Continued Next Page)

DESCRIPTIVE DATA (Continued)

FUEL

WARNING

USE OF UNAPPROVED FUELS MAY RESULT IN DAMAGE TO THE ENGINE AND FUEL SYSTEM COMPONENTS, RESULTING IN POSSIBLE ENGINE FAILURE.

Approved Fuel Grades (and Colors):

- 100LL Grade Aviation Fuel (Blue)
- 100 Grade Aviation Fuel (Green)

NOTE

Isopropyl alcohol or Diethylene Glycol Monomethyl Ether (DiEGME) may be added to the fuel supply in accordance to TCM Service Information Letter (SIL99-2B). Refer to Section 8 for additional information.

FUEL CAPACITY

Total Capacity	25.46 U.S. GALLONS (96.34 l)
Total Usable	24.00 U.S. GALLONS (90.82 l)
Total Capacity Each Tank	12.73 U.S. GALLONS (48.17 l)
Total Usable Each Tank	12.00 U.S. GALLONS (45.41 l)

NOTE

- To ensure maximum fuel capacity and minimize crossfeeding when refueling, always park the airplane in a wings level, normal ground attitude. Refer to Figure 1-1 for normal ground attitude dimensions.
- The fuel filler assembly is equipped with indicator tabs for 3/4, 1/2 and 1/4 fuel quantities.
- Maximum full capacity is indicated when fuel reaches the upper hole of the indicator tab. This fuel level allows for proper thermal expansion. Filling the fuel tank above the upper hole eliminates expansion space resulting in fuel venting overboard through the fuel vent.

(Continued Next Page)

DESCRIPTIVE DATA (Continued)

OIL

OIL SPECIFICATION

SAE J1966 Aviation Grade Non-Dispersant Mineral Oil: Used when the airplane was delivered from the factory and should be used to replenish the supply during the first 25 hours. This oil should be drained and the filter changed after the first 25 hours of operation. Refill the engine with SAE J1966 Aviation Grade Non-Dispersant Mineral Oil and continue to use until a total of 50 hours has accumulated or oil consumption has stabilized.

SAE J1899 Aviation Grade Ashless Dispersant Oil: Oil conforming to Teledyne Continental Motors (TCM) Service Information Letter SIL99-2B, and all revisions and supplements thereto, **must be used** after first 50 hours or oil consumption has stabilized.

RECOMMENDED VISCOSITY FOR TEMPERATURE RANGE

Multiviscosity or straight grade oil may be used throughout the year for engine lubrication. Refer to the following table for temperature versus viscosity ranges.

Temperature	SAE J1966 Non-Dispersant Mineral Oil SAE Grade	SAE J1899 Ashless Dispersant Oil SAE Grade
Above 4°C (40°F)	50	50 or 15W-50 or 25W-60
Below 4°C (40°F)	30	30 or 15W-50 or 25W-60
All Temperatures	M20W-50	15W-50, 20W- 50 or 25W-60

NOTE

When operating temperatures overlap, use the lighter grade of oil.

OIL CAPACITY

Sump 5.0 U.S. QUARTS (4.73 l)
 Total 5.5 U.S. QUARTS (5.20 l)
 Minimum Operating Quantity 3.5 U.S. QUARTS (3.31 l)

(Continued Next Page)

DESCRIPTIVE DATA (Continued)

MAXIMUM CERTIFICATED WEIGHTS

Ramp Weight:	1324 POUNDS (600.6 kg)
Takeoff Weight	1320 POUNDS (598.8 kg)
Landing Weight	1320 POUNDS (598.8 kg)

MAXIMUM WEIGHT IN BAGGAGE COMPARTMENT

Baggage Area (Station 155 to 190)	50 POUNDS (22.68 kg)
---	----------------------

STANDARD AIRPLANE WEIGHTS

Standard Empty Weight	834 POUNDS (378.3 kg)
Maximum Useful Load	486 POUNDS (220.4 kg)

CABIN AND ENTRY DIMENSIONS

Detailed dimensions of the cabin interior and entry door openings are illustrated in Section 4.

BAGGAGE SPACE AND ENTRY DIMENSIONS

Dimensions of the baggage area are illustrated in detail in Section 4.

SPECIFIC LOADINGS

Wing Loading	11.0 lbs/sq. ft. (53.7 kg/sq. m)
Power Loading	13.2 lbs/HP

AIRPLANE AND SYSTEMS DESCRIPTION

TABLE OF CONTENTS

	Page
Introduction	2-3
Airframe	2-3
■ Flight Controls	2-3
Instrument Panel, Flight and System Instruments	2-5
Landing Gear and Brake System	2-6
Miscellaneous Cabin Features	2-7
Engine	2-8
Engine Controls	2-8
Engine Instruments	2-9
Tachometer (RPM)	2-9
Oil Pressure (OIL PSI)	2-10
Oil Temperature (OIL °F)	2-11
■ Exhaust Gas Temperature (EGT °F) (if installed)	2-11
Carburetor Temperature (CARB °F)	2-12
New Engine Break-In And Operation	2-12
Engine Lubrication System	2-13
Ignition And Starter System	2-13
Air Induction System	2-14
Exhaust System	2-14
Cooling System	2-14
Propeller	2-15
Fuel System	2-15
■ Fuel Distribution	2-15
Fuel Indicating System	2-16
Fuel Venting	2-17
Reduced Tank Capacity	2-18
Fuel Drain Valves	2-19

TABLE OF CONTENTS

	Page
Electrical System	2-19
Master Switch	2-21
Electrical System Monitoring	2-21
Main Battery Current (Amps)	2-21
System Voltage (Volts)	2-21
Circuit Breakers	2-22
12V Power Outlet	2-23
External Power Receptacle (if installed)	2-23
Lighting Systems	2-24
Exterior Lighting	2-24
Interior Lighting	2-24
Cabin Heating and Ventilating System	2-25/2-26
Stall Warning System	2-25/2-26

INTRODUCTION

This section provides description and operation of the airplane and its systems. Some equipment described herein is optional and may not be installed in the airplane. Refer to Section 10, Supplements, for details of other optional systems and equipment.

AIRFRAME

The airplane is an all metal, two-place, high wing, single-engine airplane equipped with tricycle landing gear and is designed for sport flying and introductory training purposes.

The sheet metal fuselage bulkhead, stringer, and skin semi-monocoque construction provide safe and comfortable environment for pilot, passenger, and baggage. Forward pivoting seats allow access to the baggage area. Wing struts and main landing gear legs attach to an I-beam structure under the baggage area behind the seats. Nose gear and engine mount assembly attach to the firewall separating the cabin from engine compartment.

The aft fuselage empennage (tail assembly) consists of horizontal and vertical stabilizers, the rudder, a left elevator, and a right elevator with elevator trim tab. Attaching on either side the fuselage above the cabin, the wing contains fuel tanks at the wing root between the forward and aft spars. Aft of the rear wing spar are mounted the flaps (inboard) and ailerons (outboard). In addition to the fuselage carry-through spars, the wing is attached by forward-spar-to-fuselage struts. The wing, empennage, and flight control surfaces are also made of sheet metal spars, ribs, and skin semi-monocoque construction with balance weights incorporated into the rudder, elevators, and ailerons.

FLIGHT CONTROLS

The airplane's flight control system consists of conventional aileron, rudder, and elevator control surfaces manually operated through a cable system. An elevator trim tab is located on the right elevator. Trim tab operation is by direct linkage to a elevator mounted electric servo motor controlled by a control stick mounted trim switch. Elevator trim tab position is displayed on the Engine Indicating System area of the G300 display.

(Continued Next Page)

FLIGHT CONTROLS (Continued)

Dual under panel control sticks are used for aileron and elevator control. The under panel control sticks mimic the control movement of a floor mounted control stick while providing ease of entry to the cabin. The control stick location is designed so that the pilot's hand naturally falls on the control stick with the outboard arm on the door arm rest.

Rudder pedals with toe brakes provide rudder control through forward and aft individually adjustable pilot and copilot pedal assemblies. Rudder pedals should be adjusted so that it is possible to have full brake pedal deflection when the same side rudder is fully deflected.

Wing flaps are manually operated down by a flap handle located between the seats and returned to faired UP position by air load and return spring assist. Flap detent position UP, 10°, 25°, or FULL may be selected only after depressing the release button in the end of the flap handle.

A control gust lock is provided. The control lock pins the left control stick through a bracket to immobilize the ailerons and elevator. Rudder is held centered by the springs used for increasing rudder pedal force.

During the preflight walk-around inspection it is possible to move the ailerons into an over-centered position by moving the aileron down from the centered or faired with the flaps UP flaps position. The down-deflected aileron may appear to be stuck or difficult to move up. This is normal characteristic of the Cessna 162 ailerons system that only occurs when the ailerons are moved down from outside the airplane. It is recommended that the aileron movement be checked by moving the ailerons up from the flaps UP faired position then returned to this position. However if an aileron is externally moved down and becomes over-centered, simply re-center the cockpit control stick and continue the walk-around inspection.

CAUTION

AILERON OVER CENTERING ONLY OCCURS WHEN AILERONS ARE MOVED FROM OUTSIDE THE AIRPLANE. CONTROL STICK STIFFNESS OR STICKING IN ANY DIRECTION OF ANY CONTROL SURFACE THIS IS NOT NORMAL AND SHOULD BE INSPECTED BY MAINTENANCE PERSONNEL PRIOR TO FLIGHT.

INSTRUMENT PANEL, FLIGHT AND SYSTEM INSTRUMENTS

NOTE

Refer to the Garmin Pilot's Guide for details and operating instructions of the G300 Avionics System.

The Model 162 Skycatcher instrument panel is oriented around the Garmin G300 Flight and Engine Instrumentation Display(s). Directly in front of the pilot is the G300 Primary Flight Display (PFD) which has all flight, navigation, and engine instruments depicted in an electronic format on a liquid crystal display. A vast amount of additional flight and navigational information is accessible through the G300 system's various selectable pages. Left of the PFD on the upper panel is the optional autopilot controller unit (if installed) and below it is the Ignition/Magneto key switch.

The electrical system switch/circuit breaker panel, located to the right of the PFD, has switches in the top row with two rows of circuit breakers underneath. On the right end of the switch row is the PANEL LIGHT control knob. Under the electrical system panel is the radio stack with the Garmin SL40 Communication radio over the Garmin 327GXT Transponder.

An optional Garmin Multifunction Display (MFD) (if installed) is located to the right of the electrical system switch/circuit breaker panel. The MFD (when installed) takes over the moving map and engine instrument functions from the PFD as well as other display page functions. On the far right side of the panel is the remote ELT switch and optional intercom control panel.

Engine controls are located below the radio stack and MFD display (if installed) along the bottom center of the instrument panel. The controls are (left to right): Carb Heat, Throttle Control, Mixture Control, and Cabin Heat Control. The parking brake and fuel shut-off control knobs are located beneath the engine controls on the top of the vertical pedestal. Headset jacks and auxiliary 12 volt cabin power outlet are positioned further down on the vertical pedestal.

(Continued Next Page)

INSTRUMENT PANEL, FLIGHT AND SYSTEM INSTRUMENTS (Continued)

Behind the instrument panel are the servo units for the optional autopilot, Garmin ADAHRS (Air Data, Attitude, and Heading Reference System) Unit, and the Secondary Battery. The ADAHRS unit is a multifunctional processing unit which takes pitot-static pressures from the pitot tube on the left wing and the static source button aft of the left cowl for altitude, airspeed, and vertical speed information, tailcone mounted magnetometer data for heading, and engine data for display on the Engine Indication System (EIS) portion of the displays.

Fuel indicators are mounted in each wing root with silver float balls for visual ease. The fuel placards are differentiated between level-flight (LVL FLT) and on-ground (GRND). The **MIN/TO** reference mark on the GRND side indicates the $\frac{1}{4}$ fuel requirement for take-off. In-tank fuel tabs are equipped with indicator holes for full, $\frac{3}{4}$, $\frac{1}{2}$, and the bottom of the tab indicates $\frac{1}{4}$ (minimum takeoff). See Fuel System description section for more information.

The optional magnetic compass (if installed) is mounted to the airplane structure above the center of the windshield.

LANDING GEAR AND BRAKE SYSTEM

The tricycle type landing gear on the Model 162 features tapered spring steel main gear legs and a spring steel nose gear with elastimetric pucks for shock absorption. The nose gear is free-castoring and directional control is done via differential braking. This permits very tight turning and maneuvering in confined spaces. Full rudder deflection can assist directional control when taxiing.

Disc brakes located on the main gear wheels are hydraulically actuated by master cylinders on each rudder pedal. A parking brake valve locks brake pressure to the disc calipers when the parking brake handle on the lower instrument is pulled with the brake pedals depressed. The hydraulic brake system is connected in series running from the firewall mounted reservoir to the copilot's master cylinder then to the pilot's master cylinder then to the brake caliper through the parking brake valve.

MISCELLANEOUS CABIN FEATURES

The cabin is accessed through gas-cylinder assisted doors hinged at the top. In this manner, the doors swing up and out of the way for ease of entry and loading of cargo. Proper operation and care of the cabin doors will ensure years of flying enjoyment.

CAUTION

THE CABIN DOORS SHOULD NOT BE SLAMMED. THE DOORS DO NOT USE A PRE-CATCH MECHANISM AND SHOULD NOT BE SLAMMED CLOSED AS THIS WILL ONLY ACCELERATE WEAR ON THE DOOR ASSEMBLY.

Doors should be latched from inside by pulling the door closed and while holding the door closed, articulating the door latch handle as indicated by the placard. Externally, the door latch handle is operated through a vertical arc as indicated by the placard. Pulling the external handle horizontally may damage the mechanism and door.

The baggage area is accessed by tilting the seats forward and can accommodate up to 50 pounds of cargo. Tie-down rings are supplied to secure cargo. A tailcone close-out net is installed separating the baggage area from the aft tailcone. The net is easily removed for maintenance access but it must be installed for flight to prevent any loose objects or baggage from migrating into the tailcone area causing control and/or center of gravity issues.

Fire Extinguisher is installed for easy reach behind the cabin seats in the baggage area. Extinguisher charge should be checked as part of each preflight inspection.

ENGINE

The airplane is powered by a normally aspirated, direct drive, air-cooled, horizontally opposed, carbureted four cylinder engine with a wet sump lubrication system. The engine is a Teledyne Continental O-200-D rated at 100 horsepower at 2750 RPM. Major accessories include a starter, gear-driven alternator, dual magnetos and a full flow oil filter mounted on the rear of the engine accessory case.

ENGINE CONTROLS

Engine power is set using the throttle control. The throttle control is a smooth black knob located at the center of the instrument panel. The throttle control is configured so that the throttle is open in the forward position and closed in the full aft position. A friction lock, located at the base of the throttle control knob, is operated by rotating the lock clockwise to increase friction or counterclockwise to decrease friction.

Engine fuel mixture is controlled by the mixture control. The mixture control is a red knob, with raised points around the circumference, located immediately to the right of the throttle control and is equipped with a lock button in the end of the knob. The rich position is full forward, and full aft is the idle cutoff position. For small adjustments, the control may be moved forward by rotating the knob clockwise, and aft by rotating the knob counterclockwise. For rapid or large adjustments, the knob may be moved forward or aft by depressing the lock button in the end of the mixture control knob, and then positioning the control as desired.

(Continued Next Page)

ENGINE (Continued)

ENGINE INSTRUMENTS

The G300 Engine Indication System (EIS) provides the pilot graphical indicators and numerical values for Tachometer (RPM), Oil Pressure (OIL PSI), Oil Temperature (OIL °F), Carburetor Temperature (CARB °F), Battery Current (AMPS), and Elevator Trim Position (TRIM) along the top of the appropriate G300 Display. Additional indicators and numerical values for Exhaust Gas Temperature (EGT °F), Electrical Bus Voltage (VOLTS), and Engine Hours (ENG HRS) are displayed on the G300 ENGINE Page when selected. In normal operation, EIS information is displayed on the Primary Flight Display (PFD) in the single display installation and on the optional Multifunction Display (MFD) in the dual display configuration (if installed). During engine start or when the AVN MASTER is OFF, the EIS is only displayed on the PFD even if the optional MFD is installed.

TACHOMETER (RPM)

A speed sensor, mounted on the right magneto, provides a digital signal to the ADAHRS which processes and outputs the RPM data to the EIS.

Engine speed (RPM) is shown by the tachometer indicator found on all EIS pages. The tachometer indicator uses a circular scale with moving pointer and a digital value. The pointer moves through a range from 0 to 3000 RPM. The numerical RPM value is displayed in increments of 10 RPM in white numerals below the pointer.

The normal engine speed operating limit (top of green arc) is 2750 RPM. When engine speed is more than 2750 RPM, the pointer, digital value, and label (RPM) turn red to show engine speed is more than the limit. The digital value and label (RPM) will flash. A red-X is displayed when the instrument is invalid or out of the data range.

(Continued Next Page)

ENGINE (Continued)

ENGINE INSTRUMENTS (Continued)

OIL PRESSURE (OIL PSI)

The oil pressure transducer, connected to the engine forward oil pressure port, provides a signal to the engine display that is processed and shown as oil pressure.

■ Engine oil pressure is shown on all EIS pages. The analog instrument range is 0 to 110 PSI with digital information range from 0 to 140 PSI. The instrument has a red band from 0 to 10 PSI (low warning), a yellow band from 10 to 30 PSI (low caution), a green band from 30 to 60 PSI (normal operating range), a yellow band from 60 to 100 PSI (high caution) and a red band from 100 to 110 PSI (high warning). A white pointer indicates actual oil pressure.

When oil pressure is 0 to 10 PSI or 100 to 140 PSI, the pointer, digital value, and label (OIL PRES) will change to red to show that oil pressure is outside normal limits. A red-X is displayed when the instrument is invalid or out of the data range.

When the engine speed (RPM) is in the green arc and the oil temperature is in the green band, the oil pressure should be in the green band. If oil pressure is below the green band or above the green band, adjust the engine speed to maintain adequate oil pressure. When engine speed is at idle or near idle, the oil pressure indication must be above the lower red band. With the engine at normal operating oil temperature, and engine speed at or close to idle, oil pressure below the green band, but above the lower red band, is acceptable.

In cold weather, the oil pressure will initially be high (close to the upper red band when the engine is started). As the engine and oil warm up, the oil pressure will come down into the green band range.

(Continued Next Page)

ENGINE (Continued)

ENGINE INSTRUMENTS (Continued)

OIL TEMPERATURE (OIL °F)

The oil temperature sensor is installed in the engine oil filter adapter and provides a signal to the engine display that is processed and shown as oil temperature.

Engine oil temperature is shown on all EIS pages. The instrument range is 0 to 250°F with digital information range from 30 to 265°F. The instrument has a yellow band from 0 to 75°F (low caution), a green band from 75 to 220°F (normal operating range), a yellow band from 220 to 240°F (high caution) and a red band from 240 to 265°F (high warning). A white pointer indicates actual oil temperature.

When oil temperature is in the red band, 240 to 265°F, the pointer and OIL TEMP turn red and flash to show oil temperature is higher than the limit. A red-X is displayed when the instrument is invalid or out of the data range.

EXHAUST GAS TEMPERATURE (EGT °F) (if installed)

A thermocouple installed in the exhaust down pipe measures EGT and provides a signal to the engine display that is processed and shown on the EIS ENGINE page by the EGT °F vertical tape display and digital information. The tape indicator range is from 1000 to 1600°F, and the digital information range is from 1000 to 2000°F. The white pointer indicates actual EGT temperature. Red digits are shown for values less than 0°F and more than 2000°F. A red-X is displayed when the instrument is invalid or out of the data range.

(Continued Next Page)

ENGINE (Continued)

ENGINE INSTRUMENTS (Continued)

CARBURETOR TEMPERATURE (CARB °F)

Carburetor temperature is provided as a reference to determine the potential for carburetor ice formation. The CARB °F indication is provided on vertical tape and in digital form on the right side of the EIS display atop the PFD and on the G300 ENGINE page. The tape display range is from 20 to 80°F and the digital indication range is from -40°F to 100°F. A yellow caution range is depicted from 5°F to 40°F. A red-X is displayed when the instrument is invalid or out of the data range.

NOTE

Although carburetor ice is more likely to form at temperatures within the yellow band range, it can form at temperatures outside the yellow caution range. If engine roughness or unexplained RPM loss is encountered, full carburetor heat should be immediately applied.

NEW ENGINE BREAK-IN AND OPERATION

The initial engine run-in was accomplished at the factory and is ready for the full range of use. It is recommended that cruising be accomplished at 75% power as much as practicable until a total of 50 hours has accumulated or oil consumption has stabilized. This will ensure proper seating of the piston rings. Low cruise power settings should be used for extended descents during the first 25 hours of new engine operations. Avoid extended descents with reduced power settings.

(Continued Next Page)

ENGINE (Continued)

ENGINE LUBRICATION SYSTEM

The engine utilizes a full pressure, wet sump type lubrication system with aviation grade oil as the lubricant. The capacity of the engine sump, located on the bottom of the engine, along with the engine oil filter and oil cooler is 5.5 quarts. Oil is drawn from the sump through a filter screen on the end of a pickup tube to the engine driven oil pump. Oil from the pump then passes through a full-flow oil filter, a pressure relief valve at the rear of the right oil gallery, and an oil cooler before lubricating engine parts. The oil returns to the sump by gravity. The filter adapter in the full-flow filter is equipped with a bypass valve which will cause lubricating oil to bypass the filter in the event the filter becomes plugged, or the oil temperature is extremely cold.

An oil dipstick/filler tube is located at the left rear of the engine case. The oil dipstick/filler tube is accessed through a door located on the left side of the engine cowling. The engine should not be operated on less than 3.5 quarts of oil. For extended flight, fill to 5.0 quarts (dipstick indication only). For engine oil grade and specifications, refer to Section 8 of this POH.

IGNITION AND STARTER SYSTEM

Engine ignition is provided by two engine driven magnetos, and two spark plugs in each cylinder. The left magneto fires the lower left and lower right spark plugs, and the right magneto fires the upper left and upper right spark plugs. Normal operation is conducted with both magnetos due to the more complete burning of the fuel/air mixture with dual ignition.

Ignition and starter operation is controlled by a rotary-type switch located on the left instrument panel. The MAGNETOS switch is labeled clockwise, OFF, R, L, BOTH, and START. The engine should be operated on both magnetos (BOTH position) except for magneto checks. The R and L positions are for checking purposes and emergency use only. When the MAGNETOS switch is rotated to the spring-loaded START position, with the MASTER switch in the ON position, the starter contactor is closed and the starter, now energized, will crank the engine. When the switch is released, it will automatically return to the BOTH position.

(Continued Next Page)

ENGINE (Continued)

AIR INDUCTION SYSTEM

The engine air induction system receives ram air through an intake on the lower front portion of the engine cowling. The intake is covered by an air filter which removes dust and other foreign matter from the induction air. Airflow passing through the filter enters an air box, which is equipped with a cable operated air door for cold air or pre-heated air from a shroud around the exhaust for carburetor heat. The pre-heated air is also the source for alternate air if the air induction filter should become blocked. The pre-heated air is unfiltered and drawn through a scat tube in the cylinder baffles. Use of full carburetor heat at full throttle will result in a loss of approximately 200-250 RPM due to the increased intake temps. After passing through the air box, induction air enters a carburetor under the engine, and is then ducted to the engine cylinders through intake manifold tubes.

EXHAUST SYSTEM

Exhaust gas from each cylinder passes through a riser assembly to a common muffler, located below the engine, and then overboard through a single exhaust outlet. Outside air is supplied to a shroud constructed around the outside of the muffler to form a heating chamber. The air heated by the shroud is then supplied to the cabin.

COOLING SYSTEM

Ram air for engine cooling enters through two intake openings in the front of the engine cowling. The cooling air is directed from above the engine, around the cylinders and other areas of the engine by baffling, and then exits through an opening at the bottom aft edge of the engine cowling.

A winterization kit is available for the airplane. Refer to Section 10, Supplement 4 for description and operating information.

PROPELLER

The airplane is equipped with a two bladed, fixed pitch, one-piece forged aluminum alloy propeller which is anodized to retard corrosion. The propeller is 67 inches in diameter.

FUEL SYSTEM

The airplane fuel system, Refer to Figure 2-6, consists of two vented integral fuel tanks (one tank in each wing), fuel shutoff valve, and a fuel strainer. The engine-mounted portion of the system consists of the gravity-fed updraft float carburetor.

WARNING

UNUSABLE FUEL LEVELS FOR THIS AIRPLANE WERE DETERMINED IN ACCORDANCE WITH ASTM INTERNATIONAL COMPLIANCE STANDARDS. FAILURE TO OPERATE THE AIRPLANE IN COMPLIANCE WITH FUEL LIMITATIONS SPECIFIED IN SECTION 3 MAY FURTHER REDUCE THE AMOUNT OF FUEL AVAILABLE IN FLIGHT.

FUEL QUANTITY DATA IN U.S. GALLONS

FUEL TANKS	FUEL LEVEL (QUANTITY EACH TANK)	TOTAL FUEL	TOTAL UNUSABLE	TOTAL USABLE ALL FLIGHT CONDITIONS
Two	Full (12.73)	25.46	1.46	24.0

Figure 2-1

FUEL DISTRIBUTION

Fuel flows by gravity from the two wing tanks to a fuel shutoff valve, the fuel strainer, and to the carburetor. The carburetor meters fuel flow in proportion to induction air flow and distributes to the cylinder intake manifold.

(Continued Next Page)

FUEL SYSTEM (Continued)

FUEL INDICATING SYSTEM

Fuel quantity is measured by two sight gages located in each wing root just forward and above the cabin door opening. The sight gages are vented and include orifice fittings at the top and bottom of the sight tube. The fuel levels are aided with floating aluminum balls for increased readability. There are two scales displayed on each fuel sight gage. The aft scale shows fuel levels to be read in level flight. The markings should not be relied upon for accurate readings during skids, slips or unusual attitudes. The forward scale shows fuel levels as read on level ground. Minimum takeoff is indicated when the center of the ball is at the "MIN/TO" line on the forward scale in level ground attitude which represents 3 gallons per side or 6 gallons total (1/4 tanks).

FUEL QUANTITY SIGHT GAGE

B14537

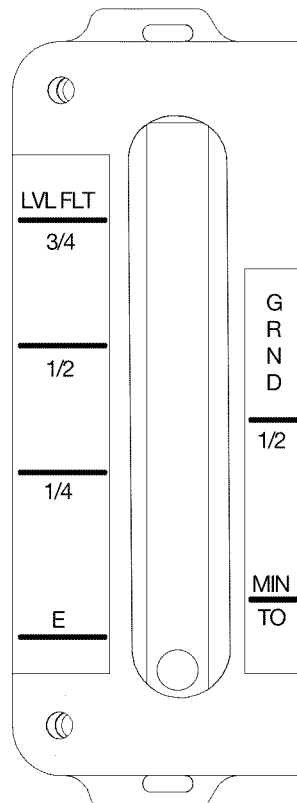

0914T1028

Figure 2-2*

(Continued Next Page)

FUEL SYSTEM (Continued)

FUEL INDICATING SYSTEM (Continued)

An empty tank is shown on the fuel quantity indicator as a red line on the aft (Level Flight) scale along with the “E” indication. When an indicator shows an empty tank, approximately 0.73 gallons of unusable fuel remain in the tank. The fuel gage shows the fuel available in the tank up to the limit of the gage measurement range of approximately $\frac{3}{4}$ tank. At this level, additional fuel may be available, but no additional indication of the fuel will be visible. A visual check of each wing tank fuel level must be performed prior to each flight. Compare the visual fuel level and indicated fuel quantity to accurately estimate usable fuel.

WARNING

TAKEOFF IS PROHIBITED IF EITHER FUEL SIGHT GAGE INDICATES BELOW THE MIN/TO INDICATION (LESS THAN 1/4 TANK) OR BELOW THE BOTTOM OF THE IN-TANK FUEL FILLER INDICATOR TAB.

FUEL VENTING

Fuel system venting is essential to system operation. Complete blockage of the fuel venting system will result in decreasing fuel flow and eventual engine stoppage. The fuel venting system consists of an interconnecting vent line between the fuel tanks and a check valve equipped overboard vent in the left fuel tank assembly. The overboard vent protrudes from the bottom surface of the left wing, just inboard of the wing strut upper attachment point. The fuel filler caps are vacuum vented; the fuel filler cap vents will open and allow air to enter the fuel tanks in case the overboard vents become blocked.

(Continued Next Page)

FUEL SYSTEM (Continued)

REDUCED TANK CAPACITY

The airplane may be serviced to a reduced capacity to permit heavier cabin loadings. This is accomplished by filling each tank to the bottom edge of the fuel filler indicator tab, thus giving a reduced fuel load of 3 gallons usable (minimum takeoff fuel) in each tank. Continued filling to each subsequent hole in the indicator tab will add an additional 3 gallons usable fuel per tank. Do not fuel above top hole as fuel expansion may cause overflow from fuel vent.

IN-TANK FUEL FILLER INDICATOR TAB

B14538

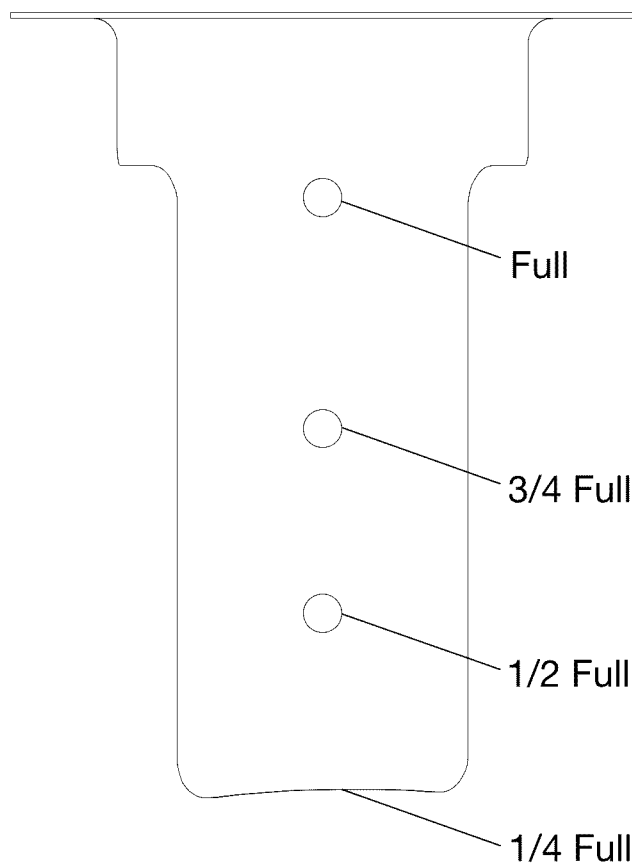

0926T1003

Figure 2-3*

(Continued Next Page)

FUEL SYSTEM (Continued)

FUEL DRAIN VALVES

The fuel system is equipped with 6 drain valves (4 in the wings and 2 in the lower cowl) to provide a means for the examination of fuel in the system for contamination and grade. The system should be examined before each flight and after each refueling, by using the sampler cup provided to drain fuel from each wing tank sump, the lower cowl fuel shutoff valve drain and the fuel strainer sump lower cowl drain. If any evidence of fuel contamination is found, it must be eliminated in accordance with the preflight inspection checklist and the discussion in Section 8. If takeoff weight limitations for the next flight permit, the fuel tanks should be filled after each flight to prevent condensation.

ELECTRICAL SYSTEM

The airplane is equipped with a 14-volt direct current (DC) electrical system powered by an engine driven alternator. A 12-volt main storage battery is located on the right forward side of the firewall. The alternator and main battery are controlled by the MASTER switch found on the switch/circuit breaker panel.

The alternator and main battery power is supplied to a relay panel located on the left forward side of the firewall. Power for all electrical circuits, except the secondary power circuit, is supplied from the relay panel to the electrical bus located in the switch/circuit breaker panel. The electrical bus is supplied with power anytime the MASTER switch is turned on. The electrical bus provides power to the avionics bus through the AVN MASTER switch. The avionics bus is supplied with power anytime the MASTER switch and AVN MASTER switch are turned on.

The electrical system is equipped with a secondary battery located between the firewall and the instrument panel. This secondary battery supplies power to the secondary power circuit for PANEL LIGHTS dimming as well as stable power to the G300 avionics and displays during engine start. This prevents undesired panel light dimming and loss of G300 information resulting from voltage drop during the engine start. The secondary battery is also controlled by the MASTER switch found on the switch/circuit breaker panel. Power is supplied to equipment on the secondary power circuit anytime the MASTER switch is turned on.

(Continued Next Page)

ELECTRICAL SYSTEM (Continued)

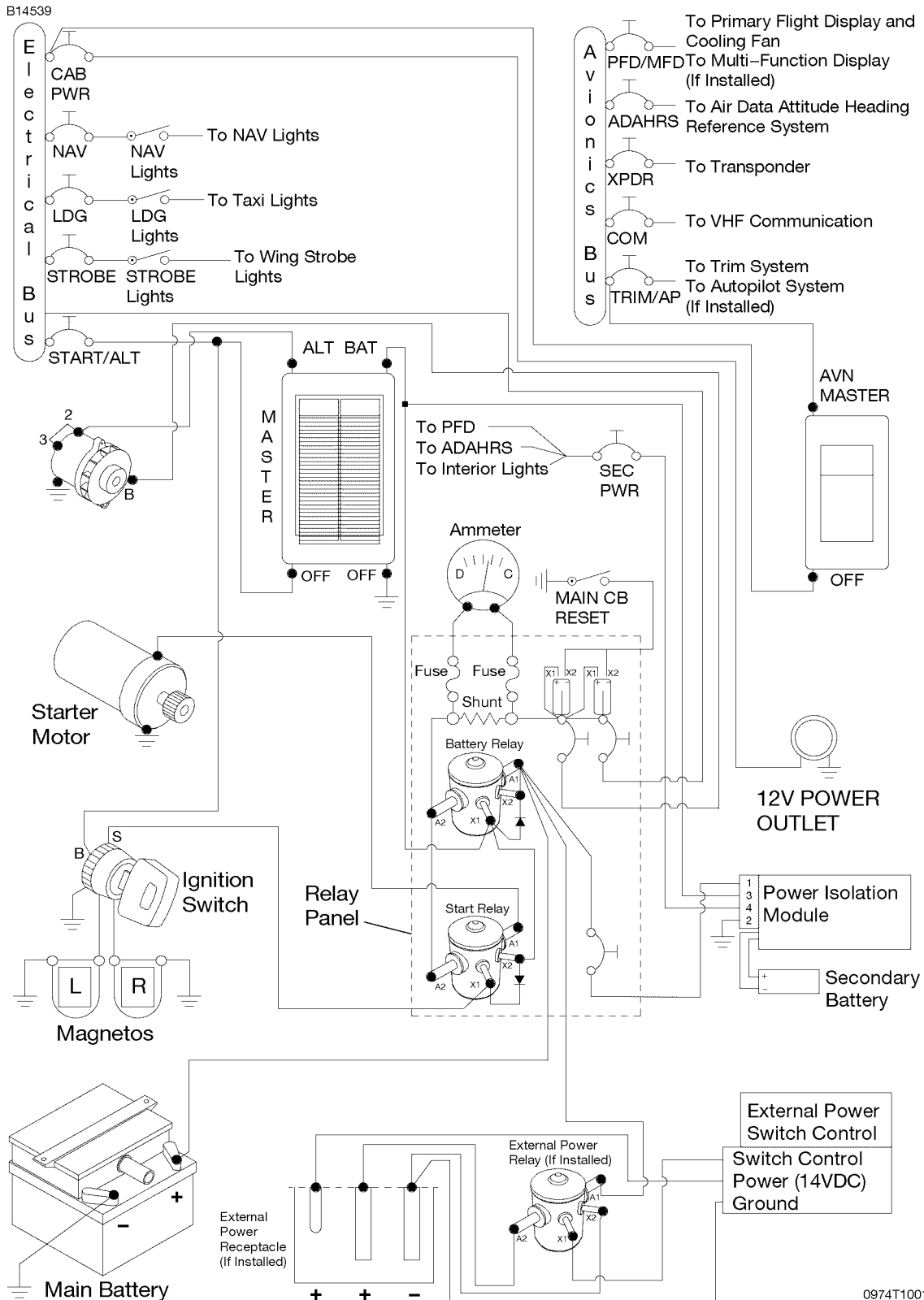

Figure 2-4*

ELECTRICAL SYSTEM (Continued)

MASTER SWITCH

The MASTER switch is a rocker type switch with two sides. The BAT side of the switch controls the electrical power to the airplane from both the main battery and secondary battery. The ALT side of the switch controls the alternator system.

In normal operation, both sides of the switch (ALT and BAT) are operated simultaneously. However, the BAT side of the switch may be selected separately as necessary. The ALT side of the switch cannot be set to ON without the BAT side of the switch also being set to ON.

ELECTRICAL SYSTEM MONITORING

Main battery current, and system voltage indications are available on the PFD during single display operation and on the MFD when a second display is available.

MAIN BATTERY CURRENT (AMPS)

The main battery current indication is shown on all G300 EIS pages. A positive number indicates a charging battery while a negative number indicates a discharging battery. The tape display range is -35 to 35 amps with digital information range from -50 to 50 amps. A red-X is displayed when the instrument is invalid or out of the data range. A white pointer indicates actual current value.

SYSTEM VOLTAGE (VOLTS)

Electrical system voltage is shown on the G300 ENGINE page. The tape display is 8 to 18 volts with digital information range from -30 to 30 volts. The tape has a red band from 8 volts to less than 12.5 volts (low warning), a green band from 12.5 to 15.0 volts (normal operating range), a yellow band from 15.0 to 16.0 volts (high caution) and another red band from greater than 16.0 volts to 18.0 volts (high warning). A red-X is displayed when the instrument is invalid or out of the data range. A white pointer indicates actual system voltage.

When the system voltage is less than 12.5 volts, a red LOW VOLTS CAS message is displayed on the bottom left side of G300 PFD attitude indicator.

ELECTRICAL SYSTEM (Continued)

CIRCUIT BREAKERS

Individual system circuit breakers are found on the switch/circuit breaker panel. All circuit breakers on this panel are capable of being opened, or disengaged from the electrical system, by pulling straight out on the outer ring for emergency electrical load management. Using the circuit breaker as a switch is discouraged since the practice will decrease the life of the circuit breaker.

The relay panel, located forward of the firewall, contains three circuit breakers associated with the alternator, main power feeder, and secondary power feeder. The alternator and main power circuit breakers are capable of being reset in flight by momentarily pushing the MAIN CB RESET switch located on the switch/circuit breaker panel.

Pushing the MAIN CB RESET switch activates the reset solenoids contained in the relay panel.

CAUTION

EXCESSIVE ACTIVATION OF THE MAIN CB RESET SWITCH WILL DECREASE SOLENOID LIFE.

Activation of the MAIN CB RESET switch is not required during normal preflight operation.

SWITCH/CIRCUIT BREAKER PANEL ASSEMBLY

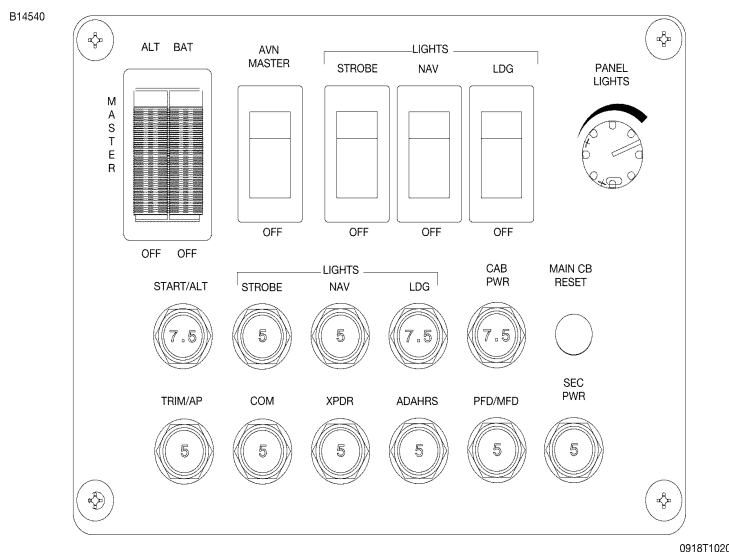

Figure 2-5*

ELECTRICAL SYSTEM (Continued)

12V POWER OUTLET

A 12 volt power outlet connector (POWER OUTLET 12V - 7.5A) is provided by an automotive style power outlet located on the center pedestal. The power outlet receives electrical power from a dedicated 7.5 amp circuit breaker located in the switch/circuit breaker panel.

CAUTION

- CHARGING OF LITHIUM BATTERIES MAY CAUSE THE LITHIUM BATTERIES TO EXPLODE.
- TAKE CARE TO OBSERVE THE MANUFACTURER'S POWER REQUIREMENTS PRIOR TO PLUGGING ANY DEVICE INTO THE 12 VOLT CABIN POWER SYSTEM CONNECTOR. THIS SYSTEM IS LIMITED TO A MAXIMUM OF 7.5 AMPS.
- USE CAUTION WITH POWER/ADAPTER CABLES IN THE CABIN TO AVOID ENTANGLING OCCUPANTS OR CABIN FURNISHINGS AND TO PREVENT DAMAGE TO CABLES SUPPLYING LIVE ELECTRIC CURRENT.
- DISCONNECT POWER/ADAPTER CABLES WHEN NOT IN USE.

EXTERNAL POWER RECEPTACLE (if installed)

The External Power Receptacle, if installed, allows the use of an external power source for cold weather starting or for lengthy maintenance work on electrical equipment. The receptacle is located on the forward left side of the firewall and is accessed through a hinged door in the engine cowling.

Anytime an external power source of correct voltage and polarity is connected to the external power receptacle, the power will be connected to the main battery regardless of MASTER switch position. In order to power onboard equipment with the external power source, the MASTER switch must be turned to the ON position.

LIGHTING SYSTEMS

EXTERIOR LIGHTING

Exterior lighting consists of navigation/strobe lights located on the wing tips and a landing/taxi light located on the outboard left wing leading edge.

All exterior lights are operated by switches found on the switch circuit breaker panel assembly to the right of the PFD. Exterior lights are grouped together in the LIGHTS section of the switch panel. To activate the LDG (landing/taxi light), NAV, and STROBE light(s), place the switch in the up position. Circuit breakers for the lights are found on the lower portion of the switch circuit breaker panel assembly.

INTERIOR LIGHTING

Instrument panel, pedestal and interior lighting is provided by an integral LED matrix light assembly mounted on the overhead cabin structure. Individual LEDs are directed at various instrument panel locations and both fuel quantity indicators for night and low-light illumination. Airplanes equipped with the BRS parachute option will also have a LED light directed at the parachute deployment handle.

The PANEL LIGHTS dimming knob, located on the right side of the electrical system switch/CB panel, controls intensity of the overhead LED matrix lighting, non-stabilized magnetic compass internal lighting (if installed) and Garmin G300 displays when the G300 display setup backlight intensity is configured in the AUTO mode.

Rotating the PANEL LIGHTS dimming knob full clockwise provides maximum brightness while rotating the dimmer control knob counterclockwise decreases light intensity from the highest level to off.

Power for the PANEL LIGHTS dimmer control is provided by the secondary power circuit and protected by the SEC PWR circuit breaker.

CABIN HEATING AND VENTILATING SYSTEM

The cabin heating and ventilating system consists of a cabin heat system and fresh air from wing leading edge openings.

Cabin heat is controlled by a push-pull cable from the CABIN HEAT control knob located on the lower instrument panel. When the CABIN HEAT control knob is placed in the ON or full aft position, air is heated as it is directed around the exhaust heat shroud and ducted to a air control valve located on the firewall. With the air control valve in the on position, warm air is directed towards the pilot's and front passenger's feet through various ducting located in the cabin. With the CABIN HEAT control knob in the off or full forward position, preheated air is redirected into the engine compartment through the air control valve located on the firewall.

Fresh air ducts direct ram air from the wing root openings to fresh air valves located overhead at the outboard corners of the windshield. These fresh air valves are equipped with directional control as well as variable flow adjustment settings.

STALL WARNING SYSTEM

Stall warning is a pneumatically operated by localized pressure differential created by low pressure airflow around the wing and higher static pressure internally. The stall warning horn will sound 5-8 knots prior to stall buffet to provide notice to the pilot of impending stall. Horn activation will not prevent a stall from occurring. When the horn sounds, the pilot should react by initiating stall avoidance procedures (decrease of angle of attack, increase airspeed, etc.). The stall warning system does not require electrical power for operation. The stall warning system opening located in the right wing should be checked during preflight to make sure it is free of debris that might interfere with airflow and correct operation. To check the system, place a clean cloth over the vent opening and apply suction; a sound from the warning horn will confirm system operation.

OPERATING LIMITATIONS

TABLE OF CONTENTS

	Page
Introduction	3-3
Airspeed Limitations	3-4
Airspeed Indicator Markings	3-5
Powerplant Limitations.	3-6
Powerplant and Electrical Instrument Markings.	3-7
Weight Limits	3-8
Maximum Weight in Baggage Compartment.	3-8
Center of Gravity Limits	3-8
■ Service Ceiling	3-8
Maneuver Limits	3-9
■ Load Factors	3-9
Flight Load Factor Limits.	3-9
Kinds of Operations Limits.	3-10
Kinds of Operations Equipment List	3-11
Fuel Limitations	3-14
Flaps Limitations	3-14
System Limitations.	3-15
12V Power Outlet	3-15
G300 Limitations	3-15
Placards.	3-16

INTRODUCTION

Section 3 includes operating limitations, instrument markings, and basic placards necessary for the safe operation of the airplane, its engine, standard systems and standard equipment. The limitations included in this section and in Section 10 have been approved. Observance of these operating limitations is required by Federal Aviation Regulations.

NOTE

- Refer to Section 10, Supplements, of this Pilot's Operating Handbook for amended operating limitations, operating procedures, performance data and other necessary information for airplanes equipped with specific options.
- The airspeeds listed in Figure 3-1, Airspeed Limitations, are based on Airspeed Calibration data shown in Section 5.

The Cessna Model No. 162 is approved under ASTM standard F2245.

AIRSPEED LIMITATIONS

Airspeed limitations and their operational significance are shown in Figure 3-1.

AIRSPEED LIMITATIONS

SYMBOL	SPEED	KCAS	KIAS	REMARKS
V_S	Stall Speed - Clean	44	41	Stall speed flap up.
V_{SO}	Stall Speed - Landing Configuration	40	37	Stall speed flaps full
V_{FE}	Maximum Flap Extended Speed: FLAPS 10° FLAPS 25° FLAPS FULL	98 84 71	100 85 70	Do not exceed this speed with flaps down.
V_O	Maximum Operating Maneuvering Speed 1320 Pounds 1200 Pounds 1100 Pounds	88 84 81	89 85 80	Maximum speed at which the airplane may be stalled without exceeding structural limitations.
V_A	Design Maneuvering Speed:	100	102	Do not make full or abrupt control movements above this speed. Does not provide protection from possible overstressing the airplane.
V_{NE}	Never Exceed Speed	143	148	Do not exceed this speed in any operation.
V_{NO}	Maximum Structural Cruising Speed	120	124	Do not exceed this speed except in smooth air, and then only with caution.

Figure 3-1

AIRSPEED INDICATOR MARKINGS

Airspeed indicator markings and their color code significance are shown in Figure 3-2.

AIRSPEED INDICATOR MARKINGS

MARKING	KIAS VALUE OR RANGE	SIGNIFICANCE
Red Band	<37	Low airspeed warning.
White Band	37 - 70	Full Flap Operating Range. Lower limit is maximum weight V_{SO} in landing configuration. Upper limit is maximum speed permissible with flaps extended.
Green Band	41 - 124	Normal Operating Range. Lower limit is maximum weight V_{S1} at most forward C.G. with flaps retracted. Upper limit is maximum structural cruising speed.
Yellow Band	124 - 148	Operations must be conducted with caution and only in smooth air.
Red Line	≥ 149	Maximum speed for all operations.
Flaps 25° Tick Mark	85	Maximum Flaps 25° Operation
Flaps 10° Tick Mark	100	Maximum Flaps 10° Operation
Vx Tick Mark	57	Best Angle of Climb Air Speed
Vy Tick Mark	62	Best Rate of Climb Air Speed

Figure 3-2

POWERPLANT LIMITATIONS

Engine Manufacturer: Teledyne Continental Motors

Engine Model Number: O-200-D

Maximum Power: 100 BHP Rating

Engine Operating Limits for Takeoff and Continuous Operations:

Maximum Engine Speed:2750 RPM

NOTE

The static RPM range at full throttle with carburetor heat off and mixture leaned to maximum RPM is 2375 - 2475 RPM. For allowable variations in static RPM at non-standard temperatures, refer to the 162 Maintenance Manual.

Maximum Oil Temperature:240°F (116°C)
Oil Pressure, Minimum:10 PSI
Oil Pressure, Maximum:100 PSI

CAUTION

ENGINE OPERATION WITH INDICATED OIL PRESSURE BELOW THE GREEN BAND RANGE WHILE IN CRUISE OR CLIMB CONFIGURATION IS CONSIDERED ABNORMAL. REFER TO SECTION 3, AMPLIFIED EMERGENCY PROCEDURES, "LOW OIL PRESSURE".

Fuel Grade: Refer to Fuel Limitations

Oil Grade (Specification):

SAE J1966 Aviation Grade Non-Dispersant Mineral Oil or SAE J1899 Aviation Grade Ashless Dispersant Oil. Oil must comply with the latest revision and/or supplement for Teledyne Continental Motors (TCM) Service Information Letter SIL99-2B or later revision, **must be used**.

Propeller Manufacturer: McCauley Propeller Systems

Propeller Model Number: 1A162/TCD6754

Propeller Diameter:

Maximum67 INCHES (1.70 m)
Minimum66 INCHES (1.68 m)

POWERPLANT AND ELECTRICAL INSTRUMENT MARKINGS

Powerplant and electrical instrument markings and their color code significance are shown in Figure 3-3. Operation with indications in the red range is prohibited. Avoid operating with indicators in the yellow range.

POWERPLANT AND ELECTRICAL INSTRUMENT MARKINGS

INSTRUMENT	RED (LOWER WARNING)	YELLOW (LOWER CAUTION)	GREEN (NORMAL OPERATING RANGE)	YELLOW (UPPER CAUTION)	RED (UPPER WARNING)
Tachometer (RPM)	----	----	2000 to 2750 RPM		2750* to 3500 RPM
Oil Temperature (OIL °F)	----	0 to 75°F	75 to 220°F	220 to 240°F	240* to 265°F
Oil Pressure (OIL PSI)	0 to 10 PSI	10 to 30 PSI	30 to 60 PSI	60 to 100 PSI	100* to 140 PSI
Exhaust Gas Temperature (if installed) (EGT °F)	----	----	1000 to 1600°F White Advisory		
Carburetor Temperature (CARB °F)		5 to 40°F			
Battery Current (AMPS)			-35 to 35 White Advisory		
Bus Voltage (VOLTS)	-30 to 12.5		12.5 to 15	15 to 16	16 to 30

*Maximum operating limit is lower end of red.

Figure 3-3

WEIGHT LIMITS

Maximum Ramp Weight: 1324 POUNDS (600.6 kg)
Maximum Takeoff Weight 1320 POUNDS (598.8 kg)
Maximum Landing Weight 1320 POUNDS (598.8 kg)

MAXIMUM WEIGHT IN BAGGAGE COMPARTMENT

■ Baggage Area (Station 155 to 190) 50 POUNDS (22.68 kg)

NOTE

Maximum baggage compartment loading must not exceed 8 pounds per square foot.

CENTER OF GRAVITY LIMITS

Center Of Gravity Range:

Forward: 134.5 inches aft of datum at 1320 pounds or less, with straight line variation to 132.0 inches aft of datum at 1050 pounds.

Aft: 136.9 inches aft of datum at all weights.

Reference Datum: Lower portion of front face of firewall.

■ **SERVICE CEILING:** 14,625 Feet (4457.7 m)

MANEUVER LIMITS

This airplane is approved under ASTM standard F2245 and is intended for recreational and instructional flight operations. In the acquisition of various pilot certificates certain maneuvers are required and these maneuvers are permitted in this airplane.

MANEUVERS AND RECOMMENDED ENTRY SPEED*

Chandelles	102 KIAS
Lazy Eights	102 KIAS
Steep Turns	102 KIAS
Stalls (Except Whip Stalls)	Slow Deceleration
Power On Stalls	Slow Deceleration

(limit pitch to 30° nose up attitude)

*** Abrupt use of the controls is prohibited above 102 KIAS.**

WARNING

AEROBATIC MANEUVERS, INCLUDING SPINS, ARE PROHIBITED.

CAUTION

INTENTIONAL OPERATION WITH CABIN DOORS OPEN IS PROHIBITED.

LOAD FACTORS

FLIGHT LOAD FACTOR LIMITS

Flight Load Factors (Maximum Takeoff Weight - 1320 POUNDS):

Flaps UP:	+4.0g, -2.0g
Flaps FULL:	+2.0g

KINDS OF OPERATIONS LIMITS

The Cessna 162 airplane is approved for DAY - NIGHT - VFR operations only. Flight into known icing conditions is prohibited.

The minimum equipment for approved operations required under the Operating Rules are defined by 14 CFR 91 and ASTM standard F2245, as applicable.

The following Kinds of Operations Equipment List (KOEL) identifies the equipment required to be operational for airplane airworthiness in the listed kind of operations.

KINDS OF OPERATIONS EQUIPMENT LIST

System, Instrument, Equipment and/or Function	KIND OF OPERATION		COMMENTS
	V F R D A Y	V F R N I G H T	
PLACARDS AND MARKINGS			
1 - 162 POH/AFM - Garmin G300	0	0	Recommended to be accessible to pilot in flight.
2 - 162 Pilot's Checklist	1	1	Required to be accessible to pilot in flight.
3 - Garmin G300 Pilot's Guide	0	0	Recommended to be accessible to pilot in flight.
4 - Garmin G300 Cockpit Reference Guide	0	0	Recommended to be accessible to pilot in flight.
AIR CONDITIONING			
1 - Avionics Fan	1	1	
COMMUNICATIONS			
1 - VHF COM	0	0	
ELECTRICAL POWER			
1 - 12V Main Battery	1	1	
2 - 14V Alternator	1	1	
3 - Standby Battery	0	1	
4 - Ammeter	0	1	
EQUIPMENT AND FURNISHINGS			
1 - Seat Belt Assembly	1	1	Each Seat Occupant
1 - Shoulder Harness	1	1	Each Seat Occupants
FLIGHT CONTROLS			
1 - Elevator Trim System	1	1	
2 - Elevator Trim Indicator	1	1	

(Continued Next Page)

KINDS OF OPERATIONS EQUIPMENT LIST (Continued)

System, Instrument, Equipment and/ or Function	KIND OF OPERATION		COMMENTS
	V F R D A Y	V F R N I G H T	
FUEL SYSTEM			
1 - Fuel Shutoff Control Valve	1	1	
2 - Cockpit Fuel Quantity Indicator - L Tank	1	1	
3 - Cockpit Fuel Quantity Indicator - R Tank	1	1	
INDICATING/RECORDING SYSTEM			
1 - Stall Warning System	1	1	
2 - G300 System Annunciator and Warning Displays	1	1	
LANDING GEAR			
1 - Wheel Fairings	0	0	Removable
LIGHTING			
1 - PFD Bezel Lighting	0	0	
2 - PFD Display Backlighting	1	1	
3 - MFD Bezel Lighting	0	0	
4 - MFD Display Backlighting	1	1	
5 - Cockpit Overhead Panel Lighting	0	1	
6 - Aircraft Position (NAV) Lights	0	1	
7 - STROBE Light System	1	1	
8 - LAND (Landing) Light	0	1	
9 - Non-stabilized Magnetic Compass Internal Lighting (if installed)	0	0	

(Continued Next Page)

KINDS OF OPERATIONS EQUIPMENT LIST (Continued)

System, Instrument, Equipment and/ or Function	KIND OF OPERATION		COMMENTS
	V F R D A Y	V F R N I G H T	
NAVIGATION AND PITOT-STATIC SYSTEM			
1 - G300 Airspeed Indicator	1	1	
2 - G300 Altimeter	1	1	
3 - G300 Vertical Speed Indicator	0	0	
4 - G300 Attitude Indicator	0	0	
5 - G300 Directional Indicator (HSI)	0	0	
6 - G300 Turn Coordinator	0	0	
7 - G300 Magnetic Heading Indicator	1	1	
■ 8 - GPS Receiver/Navigator	A/R	A/R	As Required Per Procedure.
■ 9 - GTX 327 Mode C Transponder	A/R	A/R	As Required Per Procedure.
10 - Blind Altitude Encoder	A/R	A/R	As Required Per Procedure.
11 - Clock	0	0	
■ 12 - Magnetic Compass (if installed)	0	0	
ENGINE INDICATING			
1 - Tachometer (RPM)	1	1	
■ 2 - Carburetor Temperature Indicator (CARB °F) (if installed)	0	0	
3 - Oil Pressure Indicator	1	1	
4 - Oil Temperature Indicator	1	1	
5 - Exhaust Gas Temperature (EGT) Indicator (if installed)	0	0	
ENGINE OIL			
1 - Engine Crankcase Dipstick	1	1	

FUEL LIMITATIONS

Total Fuel:25.46 U.S. GALLONS
 (12.73 GALLONS per tank)
 Usable Fuel (all flight conditions):24.0 U.S. GALLONS
 (12 GALLONS per tank)
 Unusable Fuel:1.46 U.S. GALLONS
 (0.73 GALLONS per tank)

WARNING

TAKEOFF IS PROHIBITED IF EITHER SIGHT GAGE INDICATES LESS THAN ¼ TANK OF FUEL OR FUEL LEVEL IS BELOW THE BOTTOM OF THE FUEL INDICATOR TAB.



NOTE

To ensure maximum fuel capacity and minimize crossfeeding when refueling, always park the airplane in a wings level, normal ground attitude. Refer to Figure 1-1 for normal ground attitude definition.

Fuel remaining in the tank after the fuel quantity indicator reads “E” cannot be safely used in flight.

Approved Fuel Grades (And Colors):

- 100LL Grade Aviation Fuel (Blue)
- 100 Grade Aviation Fuel (Green)

FLAP LIMITATIONS

Approved Takeoff Range: UP to 10°
 Approved Landing Range:UP to FULL

SYSTEM LIMITATIONS

12V POWER OUTLET

The 12 Volt Power Outlet (POWER OUTLET 12V - 7.5A) is not certified for supplying power to flight-critical communications or navigation devices.

Use of the 12 Volt Power Outlet is prohibited during takeoff and landing.

G300 LIMITATIONS

NOTE

It is recommended that a current Garmin G300 Pilot's Guide or at a minimum, the current Garmin G300 Cockpit Reference Guide (CRG) be available to the pilot during flight.

Use of the MAP page for pilotage navigation is prohibited. The navigation map is intended only to enhance situational awareness. Navigation is to be conducted using only current charts, data and authorized navigation facilities.

Use of the TERRAIN information for primary terrain and obstacle avoidance is prohibited. The terrain map is intended only to enhance situational awareness. It is the pilot's responsibility to provide terrain clearance at all times.

Navigation using the G300 is not authorized north of 70° North latitude or south of 70° South latitude due to unsuitability of the magnetic fields near the Earth's poles. In addition, operations are not authorized in the following two regions:

1. North of 65° North latitude between longitude 75° W and 120° W (Northern Canada).
2. South of 55° South latitude between longitude 120° E and 165° E (region south of Australia and New Zealand).

PLACARDS

The following information must be displayed in the form of composite or individual placards.

1. In full view of the pilot: (The DAY-NIGHT-VFR entry, shown on the example below, will vary with installed equipment):

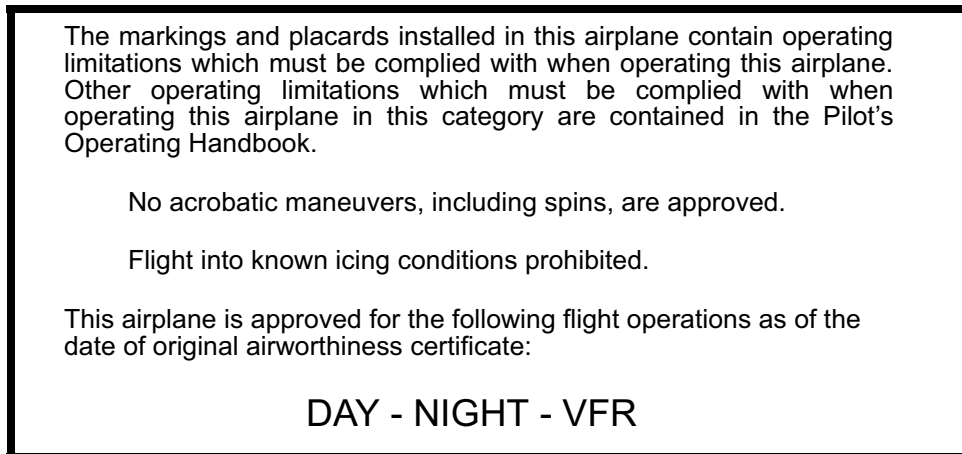

2. On control lock:

B6143

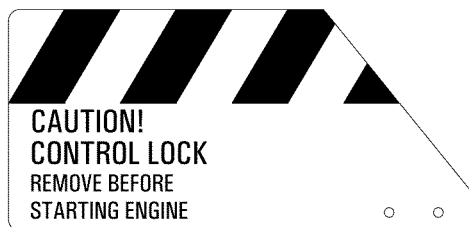

3. Silk-screened on left instrument panel above magnetos switch:

TAKEOFF PROHIBITED WITH LESS THAN 1/4 FUEL $\frac{\text{MIN}}{\text{TO}}$

(Continued Next Page)

PLACARDS (Continued)

4. Silk-screened on the lower left instrument panel:

WARNING

Assure that all contaminants, including water, are removed from fuel and fuel systems before flight. Failure to assure contaminant free fuel and heed all safety instructions and owner advisories prior to flight can result in bodily injury or death.

5. Silk-screened on the upper left instrument panel:

NO INTENTIONAL SPINS

6. On the instrument panel directly above the PFD:

**MAXIMUM OPERATING MANEUVERING SPEED: 89 KIAS
DESIGN MANEUVERING SPEED: 102 KIAS**

7. Silk-screened on the upper right instrument panel:

B6151

SMOKING PROHIBITED

8. Silk-screened on the right instrument panel:

This aircraft was manufactured in accordance with Light Sport Aircraft airworthiness standards and does not conform to standard category airworthiness requirements.

(Continued Next Page)

PLACARDS (Continued)

9. On the right side of the baggage compartment below the window:

B14615

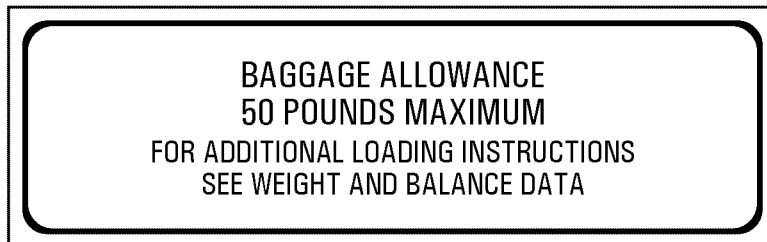

10. Near both fuel tank filler cap:

B14617

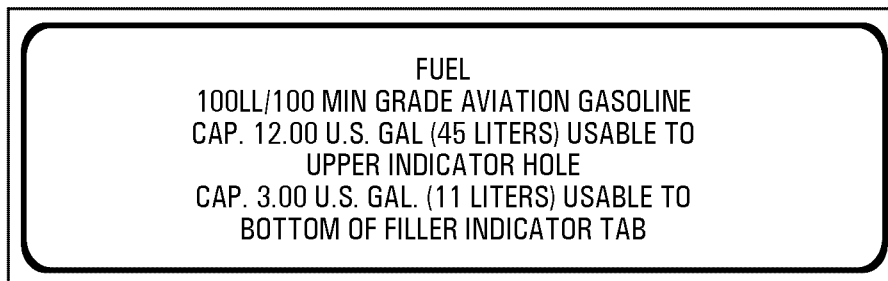

11. On the engine oil access door:

B14541

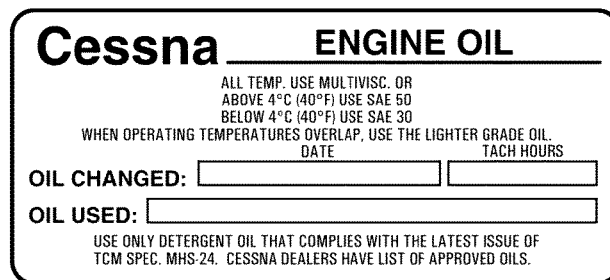

(Continued Next Page)

PLACARDS (Continued)

12. On firewall adjacent to battery box and second placard on external power receptacle door if external power receptacle option is installed:

B14616

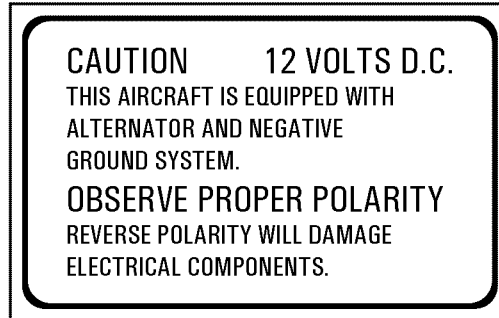

13. Located on both left and right fuel sight tubes.

B14537

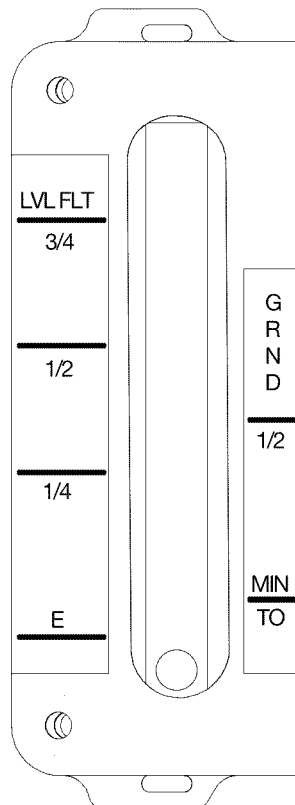

0914T1028

WEIGHT AND BALANCE/ EQUIPMENT LIST

TABLE OF CONTENTS

	Page
Introduction	4-3
Comprehensive Equipment List	4-4
Airplane Weighing Procedures	4-8
Airplane Weighing Form	4-9
Sample Weight and Balance Record	4-13
Weight And Balance	4-15
Baggage Tiedown	4-16
Sample Loading Problem	4-17
Loading Graph	4-21
Loading Arrangements	4-23
Internal Cabin Dimensions	4-25
Center Of Gravity Moment Envelope	4-27
Center of Gravity Limits.	4-29

INTRODUCTION

This section describes the procedure for establishing the basic empty weight and moment of the airplane. Sample forms are provided for reference. Procedures for calculating the weight and moment for various operations are also provided. For additional information regarding Weight and Balance procedures, refer to the Aircraft Weight and Balance Handbook (FAA-H-8083-1). A comprehensive list of Cessna equipment available for this airplane is included in this section.

Specific information regarding the weight, arm, moment and installed equipment for this airplane as delivered from the factory can be found in the plastic envelope in the back of this POH.

WARNING

IT IS THE RESPONSIBILITY OF THE PILOT TO MAKE SURE THE AIRPLANE IS LOADED PROPERLY. OPERATION OUTSIDE OF PRESCRIBED WEIGHT AND BALANCE LIMITATIONS COULD RESULT IN AN ACCIDENT AND SERIOUS OR FATAL INJURY.

COMPREHENSIVE EQUIPMENT LIST

Figure 4-1 is a comprehensive list of all Cessna equipment which is available for the Model 162 airplane equipped with Garmin G300 Integrated Cockpit System (Serials 16200001 and On). This comprehensive equipment list provides the following information in column form:

In the **ITEM NO** column, each item is assigned a coded number. The first two digits of the code represent the identification of the item within Air Transport Association Specification 100 (11 for Paint and Placards; 24 for Electrical Power; 77 for Engine Indicating, etc.). These assignments also correspond to the Maintenance Manual chapter for the airplane. After the first two digits, items receive a unique sequence number (01, 02, 03, etc.). After the sequence number, a suffix letter is assigned to identify equipment as a required item, a standard item or an optional item.

Suffix letters are as follows:

- R = Required items or equipment for ASTM certification.
- S = Standard equipment items.
- O = Optional equipment items replacing required or standard items.
- A = Optional equipment items which are in addition to required or standard items.

In the **EQUIPMENT LIST DESCRIPTION** column, each item is assigned a descriptive name to help identify its function.

In the **REF DRAWING** column, a Cessna drawing number is provided which corresponds to the item.

NOTE

If additional equipment is to be installed, it must be done in accordance with the reference drawing, service bulletin or a separate ASTM approval.

In the **WT LBS** and **ARM INS** columns, information is provided on the weight (in pounds) and arm (in inches) of the equipment item.

NOTE

- Unless otherwise indicated, true values (not net change values) for the weight and arm are shown. Positive arms are distances aft of the airplane datum; negative arms are distances forward of the datum.
- Asterisks (*) in the weight and arm column indicate complete assembly installations. Some major components of the assembly are listed on the lines immediately following. The sum of these major components does not necessarily equal the complete assembly installation.

ITEM NO	EQUIPMENT LIST DESCRIPTION	REF DRAWING	WT LBS	ARM INS.
11 - PAINT AND PLACARDS				
11-01-S	PAINT, OVERALL WHITE WITH COLOR STRIPE	0900001	19.91*	168.53
	- OVERALL WHITE COLOR	0900001	19.66	168.53
	- COLOR STRIPING	0919002	0.25	168.35
21 - AIR CONDITIONING				
21-01-S	VENTILATORS, ADJUSTABLE, CABIN AIR	0914100	0.86	122.88
21-02-S	CABIN HEATER SYSTEM, SHROUDED MUFFLER TYPE	0914100	1.01	99.15
21-03-R	AVIONICS COOLING FAN - S4000-4	0918101	0.30	116.06
22 - AUTO FLIGHT				
22-01-O	AUTOPILOT	0901120	7.14	111.41
23 - COMMUNICATIONS				
23-01-R	NAV/COM/GPS #1 COMPUTER			
	- SL40 INTEGRATED AVIONICS UNIT	0918101	2.10	117.22
	- CI2480-201 VHF COMM/GPS ANTENNA	0918123	0.56	164.78
	- CI420-10 XM ANTENNA AND CABLE ASSY	0918503	1.02	147.49
23-02-O	AUDIO INTERCOM			
	- PM3000 AUDIO PANEL	0918504	1.04	118.31
24 - ELECTRICAL POWER				
24-01-R	ALTERNATOR, 12 VOLT, 60 AMP	0950000	6.80	83.36
24-02-R	BATTERY, 12 VOLT, 14.0 AMP HOUR - PC545	0918130	11.40	98.35
24-03-S	BATTERY, STANDBY 12 VOLT - PS-1208	0918104	0.8	109.44
24-04-O	GROUND SERVICE POWER RECEPTACLE	0918505	3.21	97.84
25 - EQUIPMENT/FURNISHINGS				
25-01-R	SEAT, PILOT	0919021	7.79	146.23
25-02-S	SEAT, FRONT PASSENGER	0919021	7.79	146.23
25-03-R	SEAT BELT AND SHOULDER HARNESS, MANUAL ADJUST, PILOT	0919022	1.47	161.57
25-04-S	SEAT BELT AND SHOULDER HARNESS, MANUAL ADJUST, FRONT PASSENGER	0919022	1.47	161.57
25-05-S	BAGGAGE RESTRAINT NET	0919030	0.10	176.21
25-06-S	PILOT'S OPERATING HANDBOOK		2.00	160.59
25-07-R	PILOT'S CHECKLIST		1.00	160.59
25-08-S	GARMIN G300 PILOT'S GUIDE		1.00	160.59
25-09-S	GARMIN COCKPIT REFERENCE GUIDE		1.0	160.59
25-10-S	FUEL SAMPLING CUP		1.00	160.59
25-11-S	AK-450-C - 2 FREQUENCY ELT	0918114	2.50	201.79
	- ANTENNA AND CABLE - 450017-C		0.16	198.34
25-12-O	AK-451-C - 3 FREQUENCY ELT	0918508	2.22	201.79
	- ANTENNA AND CABLE - 450017-1B-C		0.16	198.34
25-13-O	SUN VISORS	0911010	1.65	126.44
25-14-O	BALLISTIC RECOVERY SYSTEM	0901105	34.97	168.57

Figure 4-1 (Sheet 1 of 3)

SECTION 4
WEIGHT AND BALANCE/
EQUIPMENT LIST

CESSNA
MODEL 162
GARMIN G300

ITEM NO	EQUIPMENT LIST DESCRIPTION	REF DRAWING	WT LBS	ARM INS.
26 - FIRE PROTECTION				
24-01-O	FIRE EXTINGUISHER - FIRE EXTINGUISHER, HAND TYPE - MOUNTING CLAMP AND HARDWARE	0901600-1 A344T	2.77* 2.53 0.24	160.59* 160.59 160.59
27 - FLIGHT CONTROLS				
27-01-R	DUAL CONTROLS - CONTROL STICK ASSEMBLY - RUDDER AND BRAKE PEDALS	0961510 0961331	0.85 0.46	122.98 108.02
28 - FUEL				
28-01-R	FUEL INDICATORS			
28-02-O	FUEL PRIMER ASSEMBLY	0901200	0.63	106.48
31 - INDICATING/RECORDING SYSTEM				
31-01-R	PNEUMATIC STALL WARNING SYSTEM	0914300	0.61	127.24
31-02-R	OUTSIDE AIR TEMPERATURE (OAT) PROBE	0918121	0.30	166.03
32 - LANDING GEAR				
32-01-R	WHEEL BRAKE AND TIRE, 5.00 X 5 MAIN (2) - WHEEL ASSY (EACH) - BRAKE ASSY (EACH) - TIRE AND TUBE, 4-PLY, 5.00 X 5, BLACKWALL (EACH)	0941000	4.16 1.46 5.62	149.52 151.73 149.52
32-02-R	WHEEL AND TIRE ASSY, 4.00 X 5 NOSE - WHEEL ASSY - TIRE AND TUBE, 8-PLY, 4.00 X 5, BLACKWALL	0942000	3.50 2.38	86.92 86.92
32-03-O	WHEEL FAIRING AND INSTALLATION - WHEEL FAIRING, NOSE - WHEEL FAIRINGS, MAIN (EACH)	0942200 0941200	2.56 3.48	87.57 151.72
33 - LIGHTS				
33-01-S	COCKPIT LIGHT (LED) - CL5190	0918103	012	146.00
33-02-R	NAV/STROBE LIGHT (EACH)	0928007	0.97	142.74
33-03-S	LANDING/TAXI LIGHT	0928007	1.36	129.28

Figure 4-1 (Sheet 2)

ITEM NO	EQUIPMENT LIST DESCRIPTION	REF DRAWING	WT LBS	ARM INS.
34 - NAVIGATION				
34-01-R	PFD DISPLAY - GDU 370 DISPLAY	0918101	1.56	121.56
34-02-O	MFD DISPLAY - GDU 375 DISPLAY	0918502	2.40	121.56
34-03-R	ATTITUDE HEADING REFERENCE SENSOR (ADAHRS) - GSU 73 ADAHRS	0918109	3.33	104.32
34-04-R	TRANSPONDER - GTX-327 TRANSPONDER - TRANSPONDER ANTENNA	0918101 0918122	2.40 0.06	118.76 116.91
34-05-O	COMPASS, MAGNETIC	0918509	1.15	124.94
61 - PROPELLER				
61-01-R	FIXED PITCH PROPELLER ASSEMBLY - MCCAULEY 67 INCH PROPELLER	1A162/TCD6754	24.40	65.03
	- MCCAULEY 3.115 INCH PROPELLER SPACER	B-7925	2.00	65.03
61-02-R	SPINNER INSTALLATION, PROPELLER - SPINNER SHELL	D-7945	0.90	65.03
	- SPINNER FRONT SUPPORT ASSEMBLY	C-7961	0.20	65.03
	- SPINNER BULKHEAD ASSEMBLY	D-7962	1.05	65.03
	- MOUNTING HARDWARE		1.50	65.03
71 - POWERPLANT				
71-01-R	FILTER, INDUCTION AIR	0950000	0.50	83.00
71-02-O	WINTERIZATION KIT INSTALLATION (STOWED) (INSTALLED ARM SHOWN) - BREATHER TUBE INSULATION	0901260 0901250-5, -10	1.12 0.20	70.71 75.06
	- COWL INLET COVERS (INSTALLED)	0901250-1, -2	0.92	69.77
	- COWL INLET COVERS (STOWED)	0901250-1, -2	0.92	176.21
72 - ENGINES				
72-01-R	ENGINE, TELEDYNE CONTINENTAL MOTORS O-200D	0950000	213.78	83.95
77 - ENGINE INDICATING				
77-01-R	ENGINE TACHOMETER SENSOR	0918003	0.02	92.29
77-02-O	EXHAUST THERMOCOUPLE	0918506	0.04	78.64
78 - EXHAUST				
78-01-R	EXHAUST SYSTEM	9950100	8.00	77.67
79 - OIL				
79-01-R	OIL COOLER INSTALLATION	0950000	3.83	83.36
79-02-R	OIL PRESSURE SENSOR - P165-5281	0950000	0.32	80.81
79-03-R	OIL TEMPERATURE SENSOR - S2335-1	0950000	0.15	80.81
79-04-O	OIL QUICK DRAIN INSTALLATION	0901240	0.06	90.08

Figure 4-1 (Sheet 3)

AIRPLANE WEIGHING PROCEDURES

1. Preparation:
 - a. Inflate tires to recommended operating pressures.
 - b. Defuel airplane. Refer to the Maintenance Manual.
 - c. Service engine oil as required to obtain a normal full indication (approximately 5 quarts on dipstick).
 - d. Raise flaps to the fully retracted position.
 - e. Place all control surfaces in neutral position.
 - f. Remove all non-required items from airplane.
2. Level:
 - a. Place scales under each wheel (minimum scale capacity, 1000 pounds).
 - b. Deflate the nose tire to properly center the bubble in the level (Refer to Figure 4-2).
3. Weigh:
 - a. Weigh airplane in a closed hangar to avoid errors caused by air currents.
 - b. With the airplane level and brakes released, record the weight shown on each scale. Deduct the tare, if any, from each reading.
4. Measure:
 - a. Obtain measurement A by measuring horizontally (along the airplane centerline) from a line stretched between the main wheel centers to a plumb bob dropped from the firewall.
 - b. Obtain measurement B by measuring horizontally and parallel to the airplane centerline, from center of nosewheel axle, left side, to a plumb bob dropped from the line between the main wheel centers. Repeat on right side and average the measurements.
5. Using weights from step 3 and measurements from step 4, the Basic Empty Weight and C.G. can be determined by completing Figure 4-2 (Sheet 3 or Sheet 4).
6. Changes to the Airplane Weight and Balance due to alteration or repair must be documented in a permanent record within the POH similar to that shown in Figure 4-3.
7. A new Basic Empty Weight and CG Arm based on actual airplane weight (as weighed) is required after a major repair or alteration. It is recommended that the airplane be weighed to verify Basic Empty Weight and CG Arm at intervals not to exceed 5 years.

AIRPLANE WEIGHING FORM - U.S. UNITS

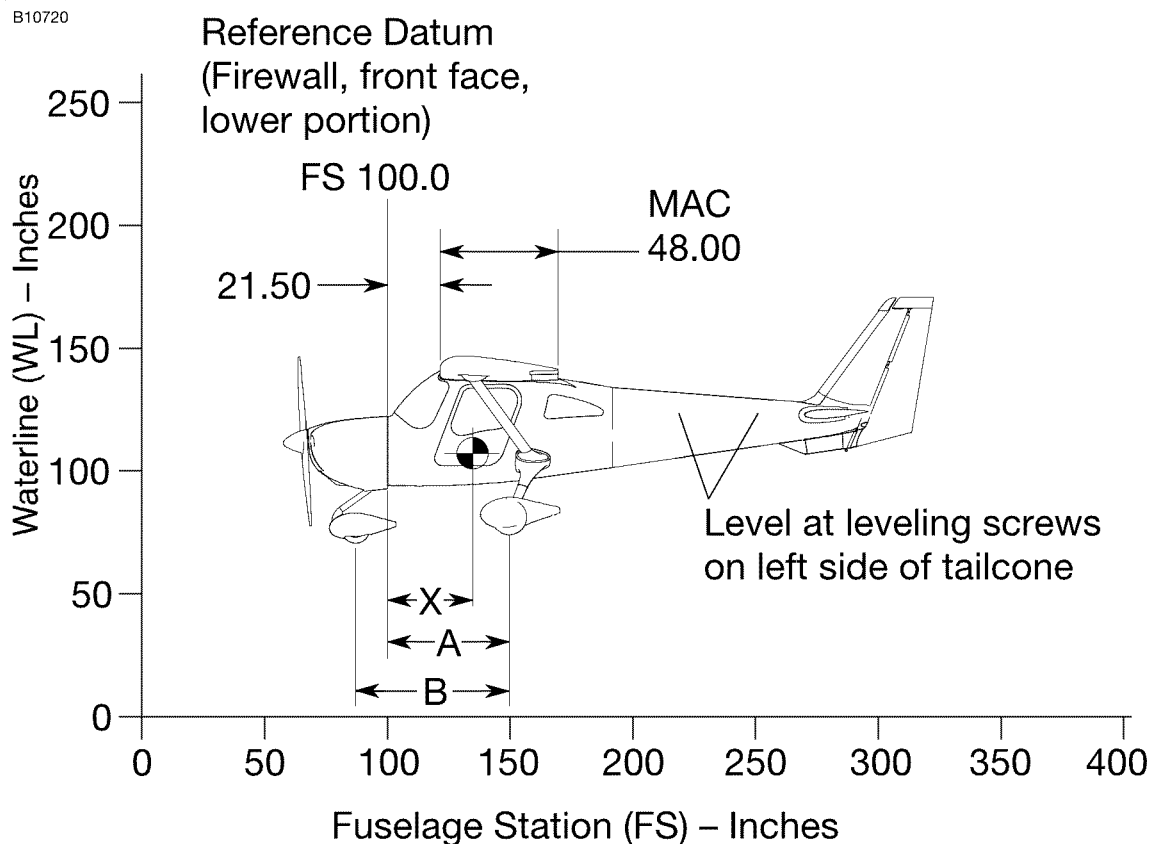

NOTE

It is the responsibility of the pilot to make sure that the airplane is loaded properly.

0910T1002

Figure 4-2* (Sheet 1 of 4)

AIRPLANE WEIGHING FORM - METRIC UNITS

B13961

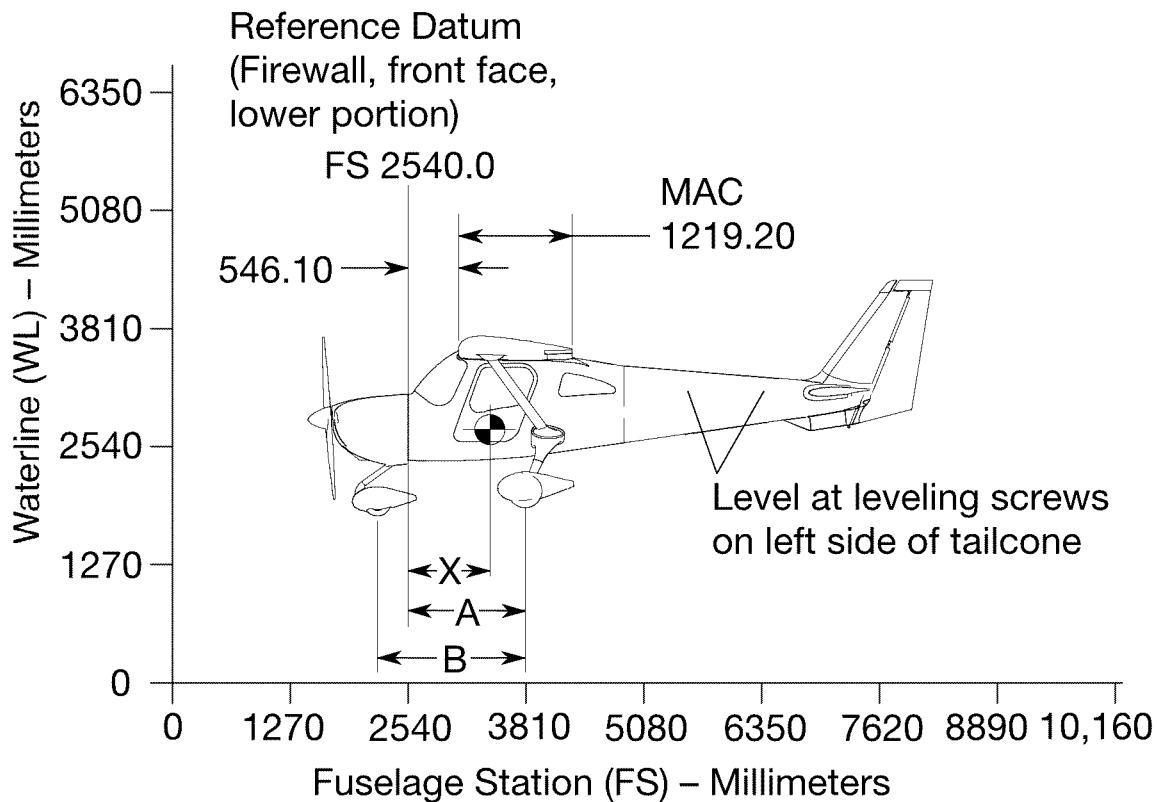

NOTE

It is the responsibility of the pilot to make sure that the airplane is loaded properly.

0910T1002

Figure 4-2* (Sheet 2)

AIRPLANE WEIGHING FORM - U.S. UNITS

B10721

Locating CG with Airplane on Landing Gear

$$X \text{ (Inches Aft of Datum)} = A - \left[\frac{\text{Nosewheel Weight} \times B}{\text{Total Weight}^*} \right] + 100 \text{ Inches}$$

Locating Percent MAC

*(Nose + L + R Wheel Weights)

$$\text{CG Percent MAC} = \frac{(\text{CG Arm of Airplane}) - 121.50 \text{ Inches}}{0.480 \text{ Inches}}$$

Measuring A and B

Measure A and B per pilot's operating handbook instructions to assist in locating CG with airplane weighed on landing gear.

Leveling Provisions

Longitudinal – Left side of tailcone at FS 218.61 Inches and 250.61 Inches

Airplane as Weighed Table

Position	Scale reading	Scale drift	Tare	Net weight
Left Wheel				
Right Wheel				
Nose Wheel				
Airplane total as weighed				

Basic Empty Weight and Center-of-Gravity Table

Item	Weight (Pounds)	CG Arm (Inches)	Moment (Inch-Pounds /1000)
Airplane (calculated or as weighed) (includes all undrainable fluids and full oil)			
Drainable unusable fuel at 6.0 pounds per gallon – (1.46 gallons)	8.76	143.26	1.25
Basic Empty Weight			

Figure 4-2 (Sheet 3)

AIRPLANE WEIGHING FORM - METRIC UNITS

B13962

Locating CG with Airplane on Landing Gear

$$X \text{ (Inches Aft of Datum)} = A - \left[\frac{\text{Nosewheel Weight} \times B}{\text{Total Weight}^*} \right] + 2540 \text{ mm}$$

Locating Percent MAC

*(Nose + L + R Wheel Weights)

$$\text{CG Percent MAC} = \frac{(\text{CG Arm of Airplane}) - 3086.1 \text{ mm}}{12.2 \text{ mm}}$$

Measuring A and B

Leveling Provisions

Longitudinal – Left side of tailcone at FS 5552.7 mm and 6365.5 mm

Measure A and B per Pilot's Operating Handbook instructions to assist in locating CG with airplane weighed on landing gear.

Airplane as Weighed Table

Position	Scale reading	Scale drift	Tare	Net weight
Left Wheel				
Right Wheel				
Nose Wheel				
Airplane total as weighed				

Basic Empty Weight and Center-of-Gravity Table

Item	Weight (Kilograms)	CG Arm (mm)	Moment (mm–kg/1000)
Airplane (calculated or as weighed) (includes all undrainable fluids and full oil)			
Drainable unusable fuel at 0.72 Kilograms per liter – (5.53 L)	3.98	3638.8	14.48
Basic Empty Weight			

Figure 4-2 (Sheet 4)

SAMPLE WEIGHT AND BALANCE RECORD - U.S.

B3099

SAMPLE WEIGHT AND BALANCE RECORD

(Continuous history of changes in structure or equipment affecting weight and balance)

Airplane model		Serial number	Page number	Weight change						Running basic empty weight	
				Added (+)			Removed (-)			WT.	Moment
Date	Item no.		Description of article or modification	WT. (lb.)	Arm (in.)	Moment /1000	WT. (lb.)	Arm (in.)	Moment /1000	WT. (lb.)	Moment /1000
	In	Out									
			As delivered								

0585T1009

Figure 4-3 (Sheet 1 of 2)

SAMPLE WEIGHT AND BALANCE RECORD - METRIC

B13963

SAMPLE WEIGHT AND BALANCE RECORD

(Continuous history of changes in structure or equipment affecting weight and balance)

Date	Airplane model		Description of article or modification	Serial number						Page number												
				Weight change			Removed (-)			WT. Moment /1000	Running basic empty weight											
	Item no. In	Item no. Out		Added (+)		Removed (-)																
WT. (kg)			Arm (mm)	WT. (kg)	Arm (mm)	WT. (kg)	Arm (mm)	WT. (kg)	Arm (mm)	WT. (kg)	Arm (mm)											
			As delivered																			

0585T1009

Figure 4-3 (Sheet 2)

WEIGHT AND BALANCE

The following information will enable you to operate your Cessna within the prescribed weight and center of gravity limitations. To determine weight and balance, use the Sample Loading Problem (Figure 4-4), Loading Graph (Figure 4-5), and Center of Gravity Moment Envelope (Figure 4-8) as follows:

Enter the appropriate basic empty weight and moment/1000 from the weight and balance records for your airplane in the YOUR AIRPLANE column of the Sample Loading Problem.

NOTE

In addition to the basic empty weight and moment noted on these records, the C.G. arm (FS) is also shown, but need not be used on the Sample Loading Problem. The moment which is shown must be divided by 1000 and this value used as the moment/1000 on the loading problem.

Use the Loading Graph to determine the moment/1000 for each additional item to be carried; then list these on the loading problem.

NOTE

Loading Graph information for the pilot, passenger and baggage is based on baggage loaded in the center of the baggage areas as shown on the Loading Arrangements diagram. For loadings which may differ from these, the Sample Loading Problem lists fuselage stations (FS) for these items to indicate their forward and aft C.G. range limitations (baggage area limitation). Refer to Figures 4-6 and 4-7 for additional loading information. Additional moment calculations, based on the actual weight and C.G. arm (FS) of the item being loaded, must be made if the position of the load is different from that shown on the Loading Graph.

Total the weights and moments/1000 and plot these values on the Center of Gravity Moment Envelope to determine whether the point falls within the envelope, and if the loading is acceptable.

(Continued Next Page)

WEIGHT AND BALANCE (Continued)

BAGGAGE TIEDOWN

A nylon baggage net, having four tiedown straps, is provided as standard equipment to secure baggage on the cabin floor. Six eyebolts serve as attaching points for the net. A placard located on the right side of the baggage compartment, below the window, defines the weight limitations in the baggage areas.

NOTE

Maximum weight in the baggage compartment area is 50 pounds (22.68 kg) with a maximum floor loading of 8 pounds per square foot (39.05 kilograms per square meter).

SAMPLE LOADING PROBLEM - U.S. UNITS

ITEM DESCRIPTION	WEIGHT AND MOMENT TABULATION			
	SAMPLE AIRPLANE		YOUR AIRPLANE	
	Weight (lbs)	Moment (lb-ins/1000)	Weight (lbs)	Moment (lb-ins/1000)
1 - Basic Empty Weight (Use the data pertaining to your airplane as it is presently equipped. Includes unusable fuel and full oil)	834	110.1		
2 - Usable Fuel (At 6 Lbs./Gal.)				
- Standard Fuel - 24 Gallons Maximum	144	20.6		
- Reduced Fuel - 12 Gallons				
3 - Pilot and Front Passenger (FS 142)	300	42.6		
4 - Baggage (FS 155 to 190) 50 Pounds Maximum	46	7.9		
5 - RAMP WEIGHT AND MOMENT	1324	181.2		
6 - Fuel allowance for engine start, taxi and runup	-4.0	-0.6		
7 - TAKEOFF WEIGHT AND MOMENT (Subtract Step 8 from Step 7)	1320	180.6		

8 - Locate this point (1320 at 180.6) on the Center of Gravity Moment Envelope, and since this point falls within the envelope, the loading is acceptable.

Figure 4-4 (Sheet 1 of 4)

SAMPLE LOADING PROBLEM - METRIC UNITS

ITEM DESCRIPTION	WEIGHT AND MOMENT TABULATION			
	SAMPLE AIRPLANE		YOUR AIRPLANE	
	Weight (kgs)	Moment (kg-mm/ 1000)	Weight (kgs)	Moment (kg-mm/ 1000)
1 - Basic Empty Weight (Use the data pertaining to your airplane as it is presently equipped. Includes unusable fuel and full oil)	378.3	1268.4		
2 - Usable Fuel (At 0.72 Kg./Liter)				
- Standard Fuel - 90.82 Liters Maximum	65.4	244.5		
- Reduced Fuel - 45.41 Liters				
3 - Pilot and Front Passenger (FS 3607)	136.1	490.9		
4 - Baggage (FS 3937 to 4826) 22.6 Kilograms Maximum	19.9	86.9		
5 - RAMP WEIGHT AND MOMENT	599.7	2090.7		
6 - Fuel allowance for engine start, taxi and runup	-1.8	-6.6		
7 - TAKEOFF WEIGHT AND MOMENT (Subtract Step 8 from Step 7)	597.9	2084.1		

8 - Locate this point (597.9 at 2084.1) on the Center of Gravity Moment Envelope, and since this point falls within the envelope, the loading is acceptable.

Figure 4-4 (Sheet 2)

SAMPLE LOADING PROBLEM - U.S. UNITS

YOUR AIRPLANE		YOUR AIRPLANE		YOUR AIRPLANE	
Weight (lbs.)	Moment (Lb-ins, /1000)	Weight (lbs.)	Moment (Lb-ins, /1000)	Weight (lbs.)	Moment (Lb-ins, /1000)

NOTE

When several loading configurations are representative of your operations, it may be useful to fill out one or more of the above columns so specific loadings are available at a glance.

Figure 4-4 (Sheet 3)

SAMPLE LOADING PROBLEM - METRIC UNITS

YOUR AIRPLANE		YOUR AIRPLANE		YOUR AIRPLANE	
Weight (Kgs)	Moment (Kgs-mm/ 1000)	Weight (Kgs)	Moment (Kgs-mm/ 1000)	Weight (Kgs)	Moment (Kgs-mm/ 1000)

NOTE

When several loading configurations are representative of your operations, it may be useful to fill out one or more of the above columns so specific loadings are available at a glance.

Figure 4-4 (Sheet 4)

LOADING GRAPH - U.S. UNITS

B10722

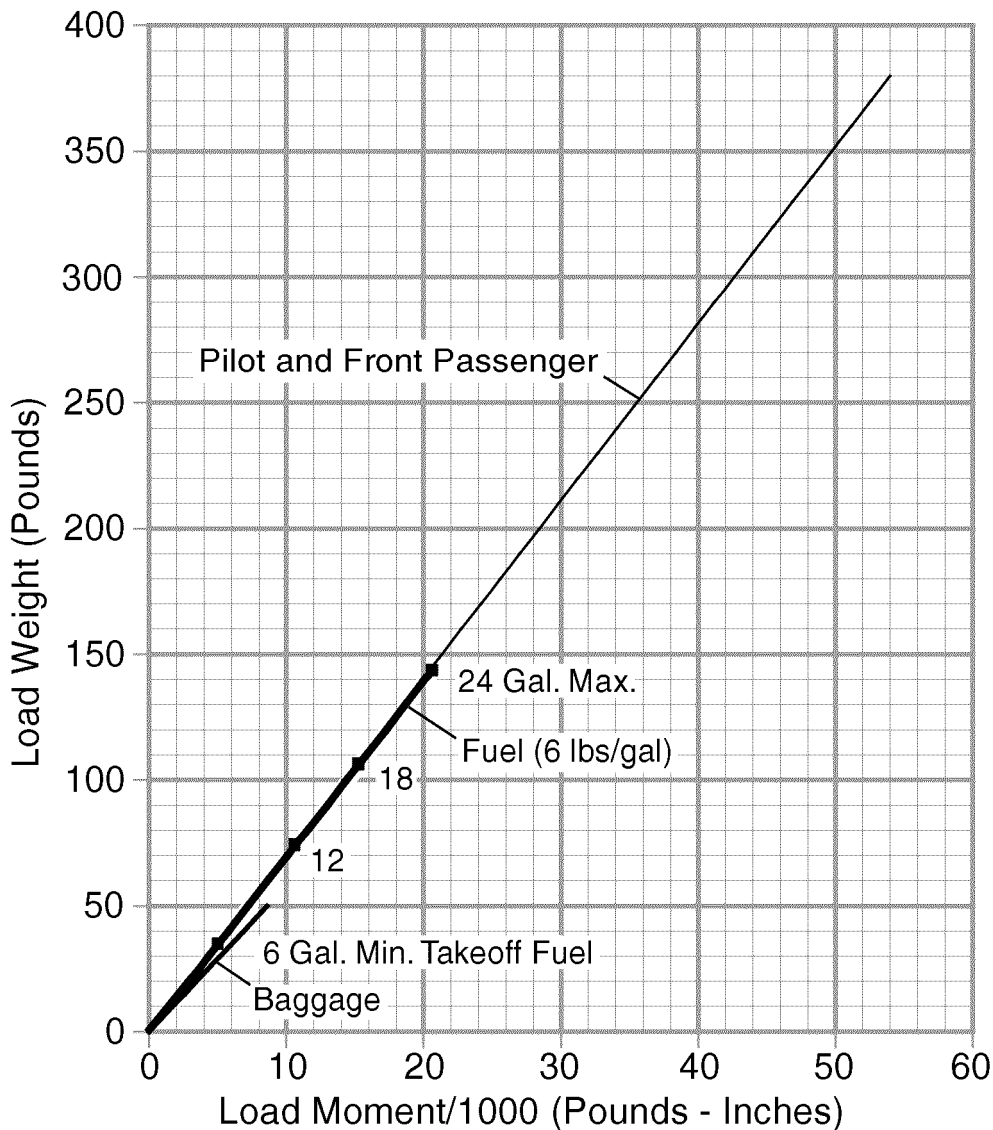

Figure 4-5 (Sheet 1 of 2)

LOADING GRAPH - METRIC UNITS

B10723

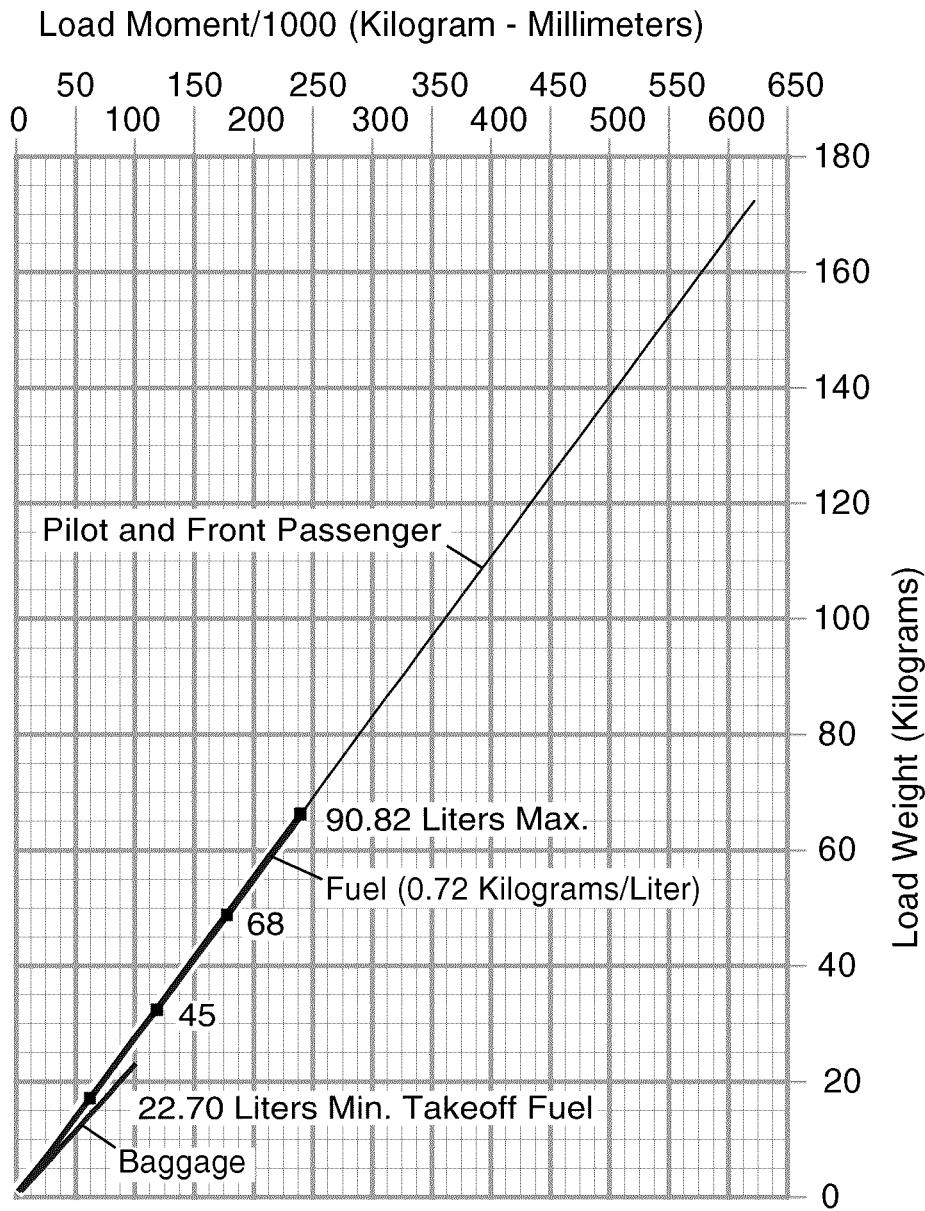
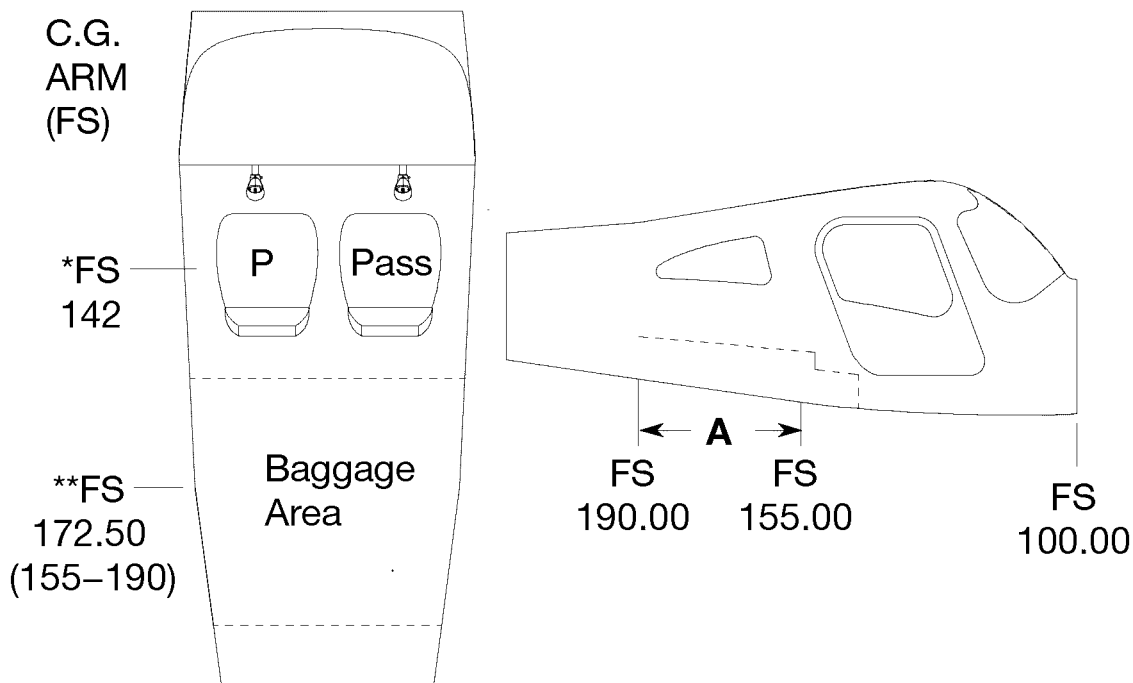

Figure 4-5 (Sheet 2)

LOADING ARRANGEMENTS - U.S. UNITS

B13964



0919020

*Pilot and front seat passenger center of gravity for average occupant.

**Arm measured to the center of the areas shown.

NOTE

- All dimensions shown are in inches.
- The usable fuel C.G. arm is located at FS 143.26.
- The aft baggage wall (approximate FS 190.00) can be used as a convenient interior reference point for determining the location of baggage area fuselage stations.

Figure 4-6* (Sheet 1 of 2)

LOADING ARRANGEMENTS - METRIC UNITS

B13965

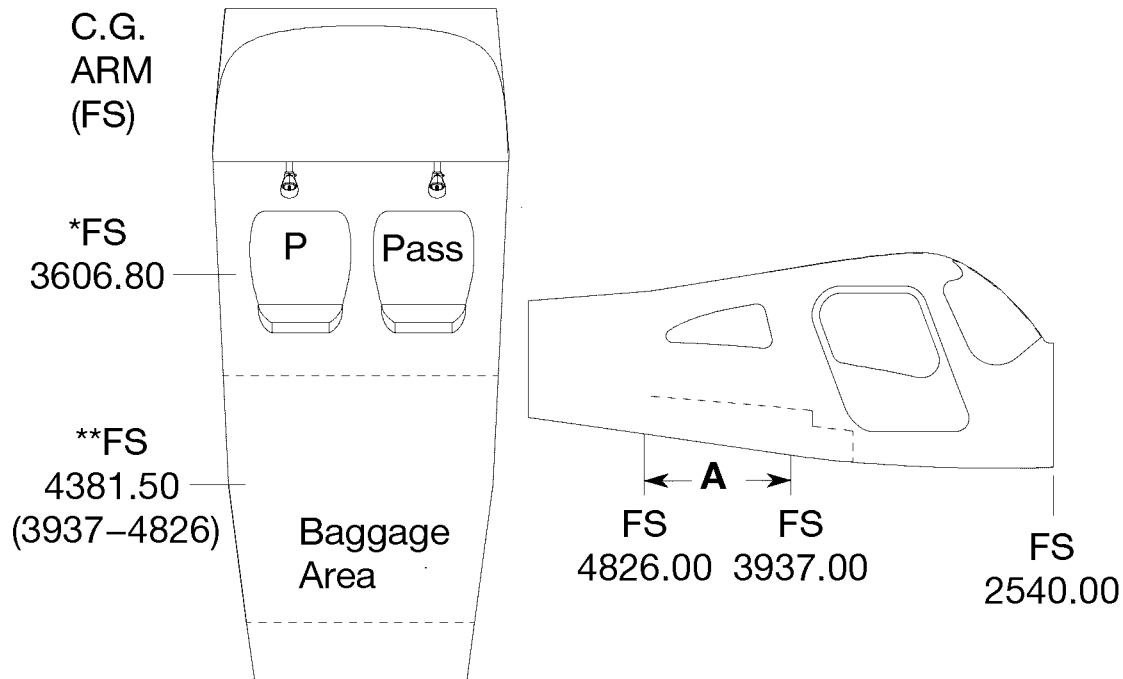

09101001

*Pilot and front seat passenger center of gravity for average occupant.

**Arm measured to the center of the areas shown.

NOTE

- All dimensions shown are in millimeters.
- The usable fuel C.G. arm is located at FS 3638.80.
- The aft baggage wall (approximate FS 4826) can be used as a convenient interior reference point for determining the location of baggage area fuselage stations.

Figure 4-6* (Sheet 2)

INTERNAL CABIN DIMENSIONS - U.S. UNITS

B10724

Cabin Height Measurements

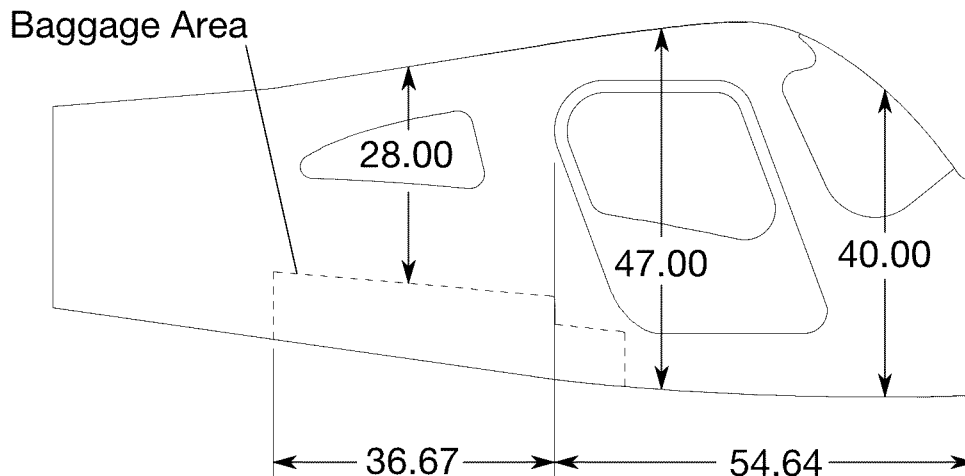

Cabin Width Measurements

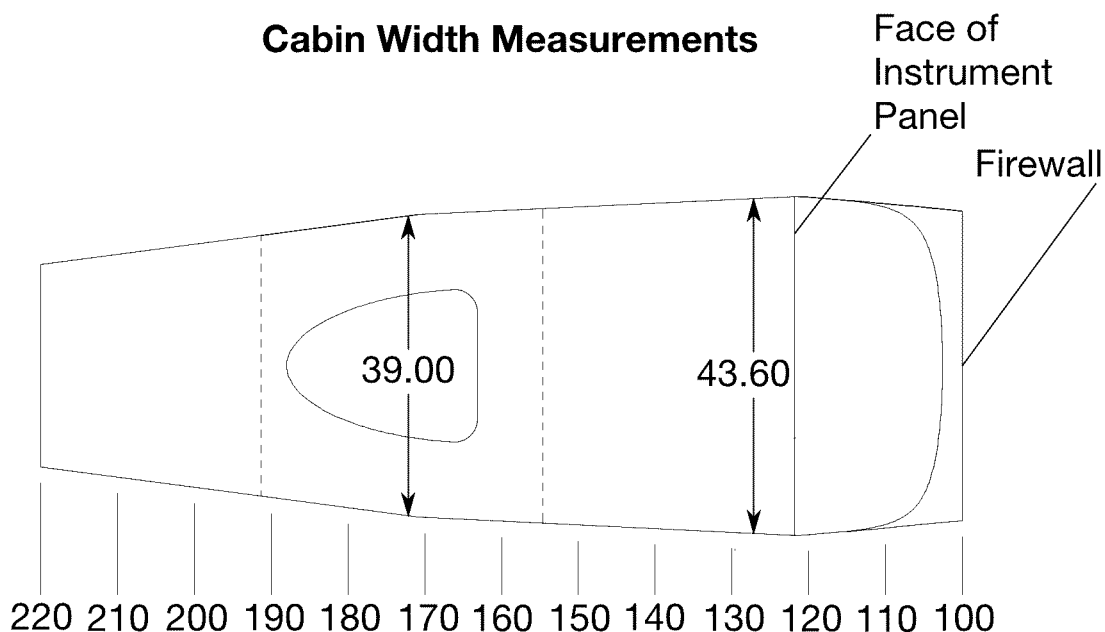

NOTE

- Maximum weight in the baggage compartment area is 50 pounds with a maximum floor loading of 8 pounds per square foot.
- All dimensions shown are in inches.

Figure 4-7 (Sheet 1 of 2)

INTERNAL CABIN DIMENSIONS - METRIC UNITS

B10725

Cabin Height Measurements

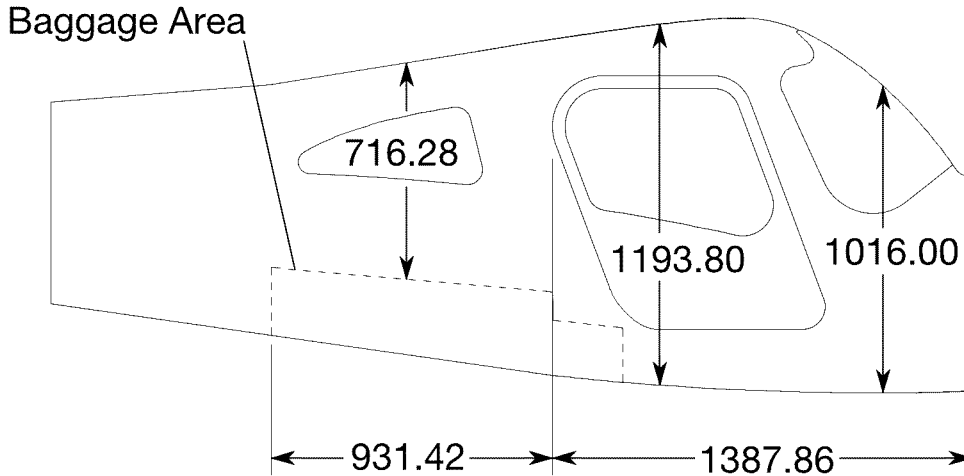

Cabin Width Measurements

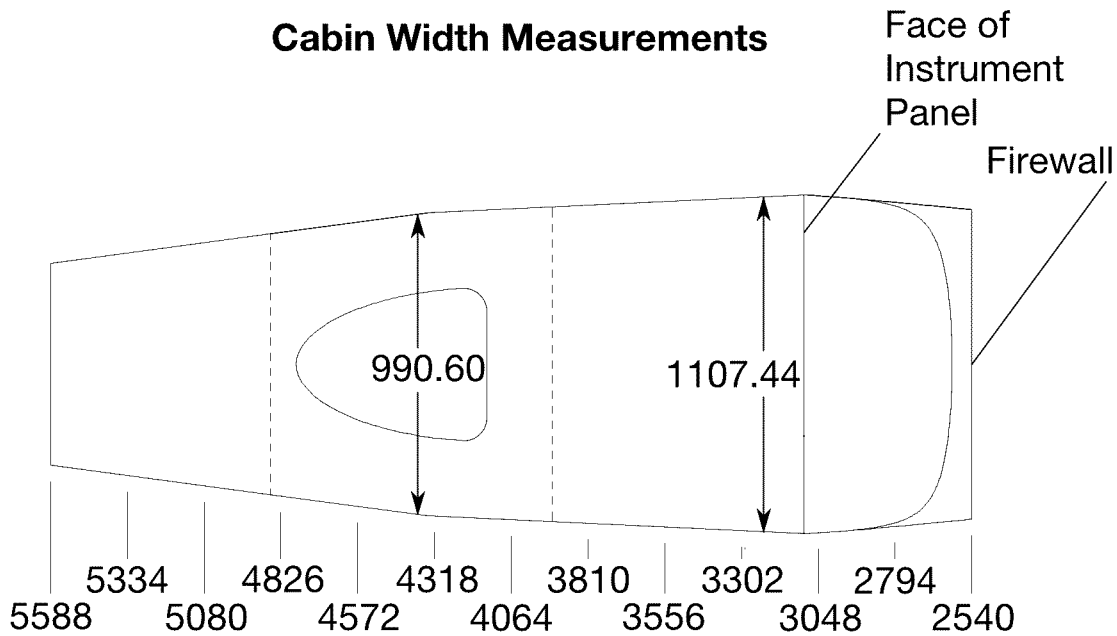

NOTE

- Maximum weight in the baggage compartment area is 22.68 kilograms with a maximum floor loading of 39.05 kilograms per square meter.
- All dimensions shown are in millimeters.

Figure 4-7 (Sheet 2)

CENTER OF GRAVITY MOMENT ENVELOPE - U.S.

B10726

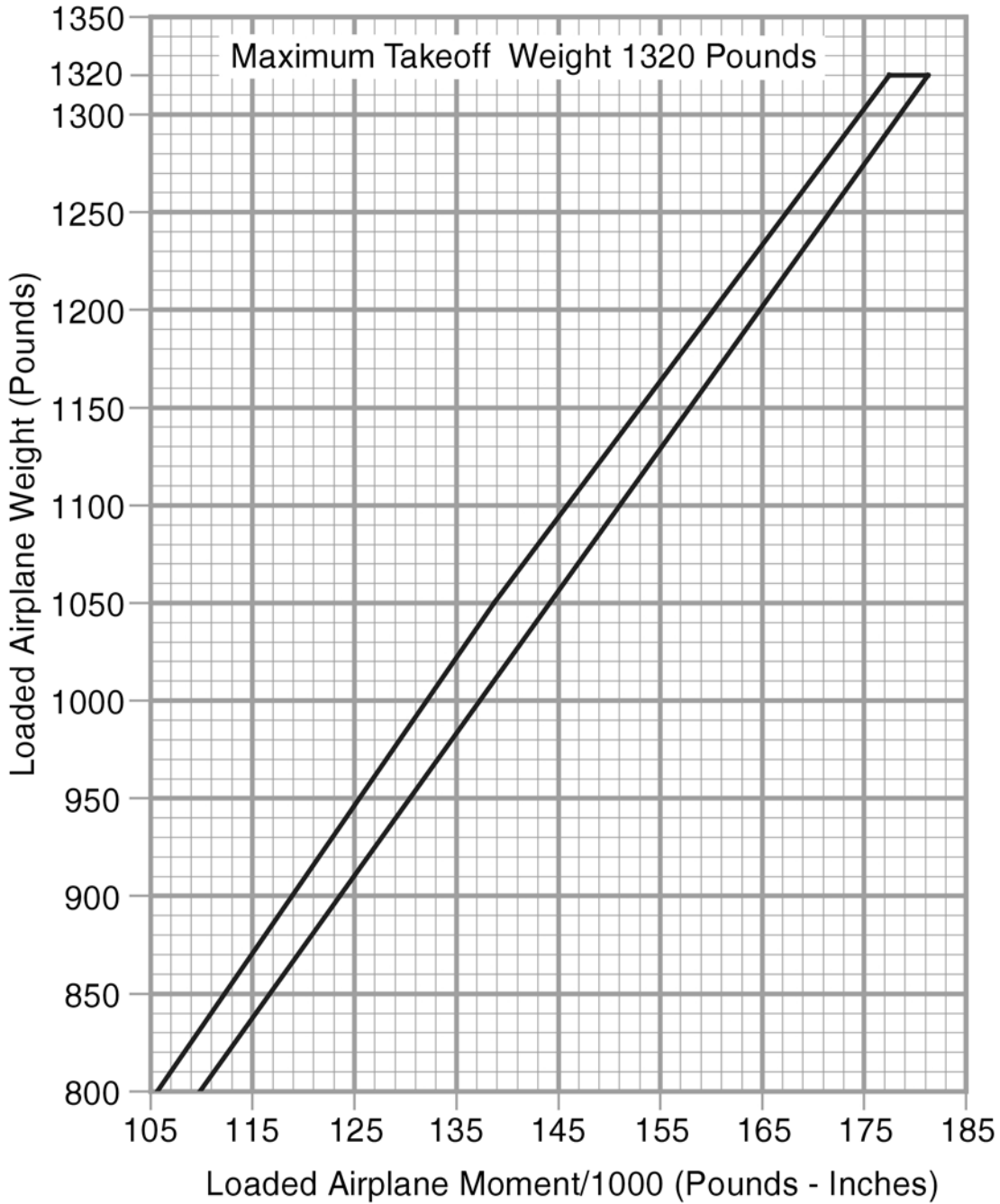

Figure 4-8 (Sheet 1 of 2)

CENTER OF GRAVITY MOMENT ENVELOPE METRIC UNITS

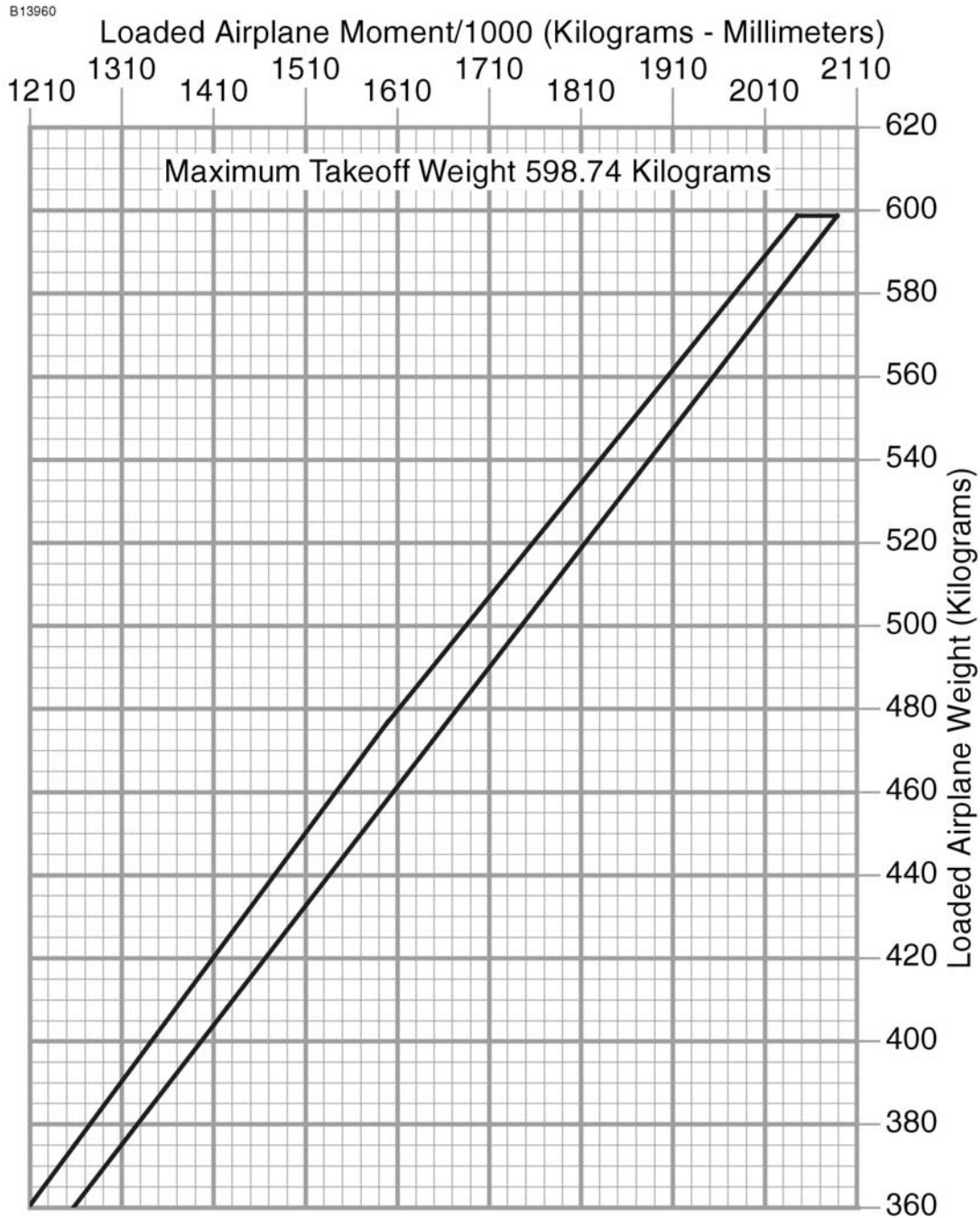

Figure 4-8 (Sheet 2)

CENTER OF GRAVITY LIMITS - U.S. UNITS

B13958

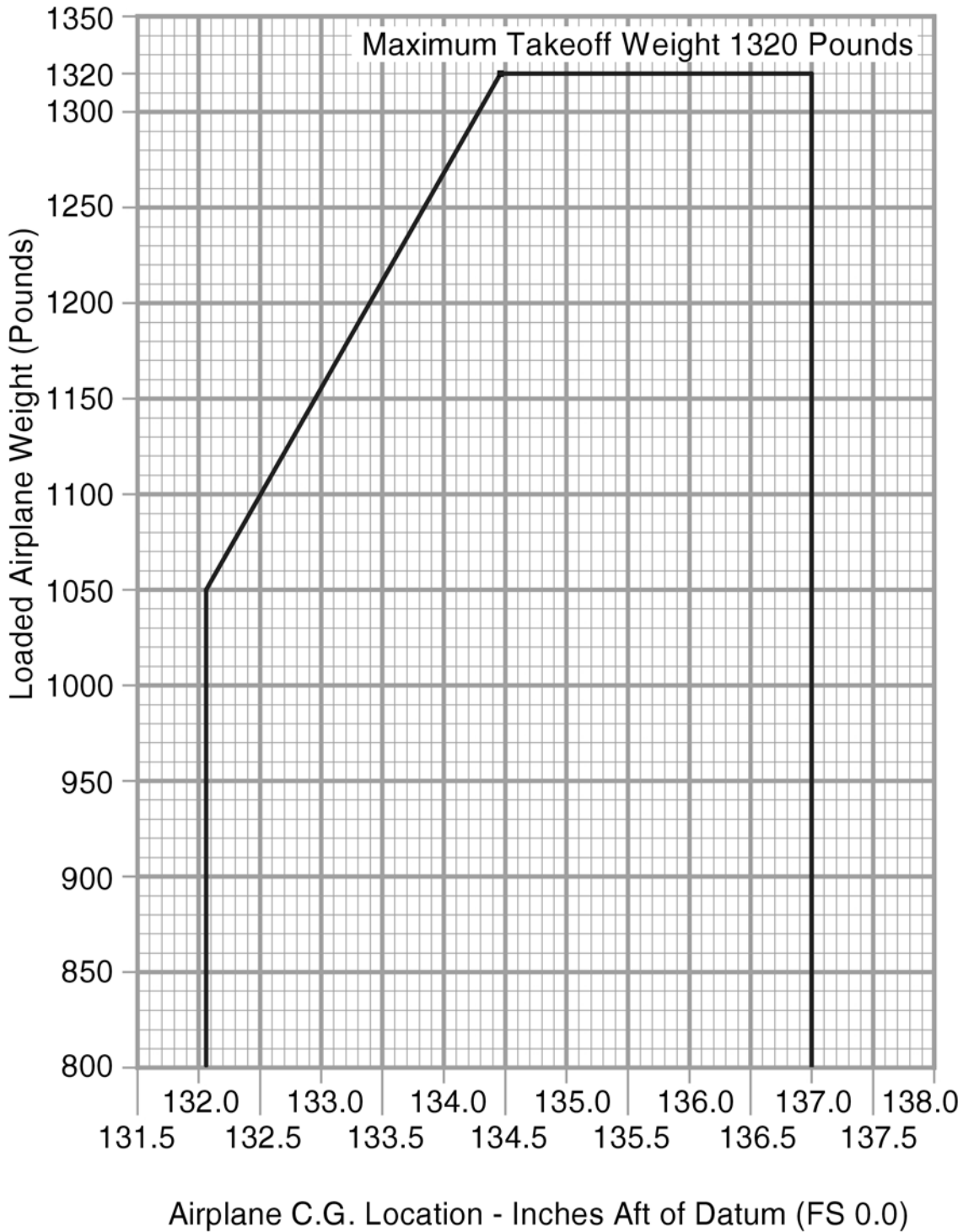

Figure 4-9 (Sheet 1 of 2)

CENTER OF GRAVITY LIMITS - METRIC UNITS

B13959

Airplane C.G. Location - Millimeters Aft of Datum (FS 0.0)

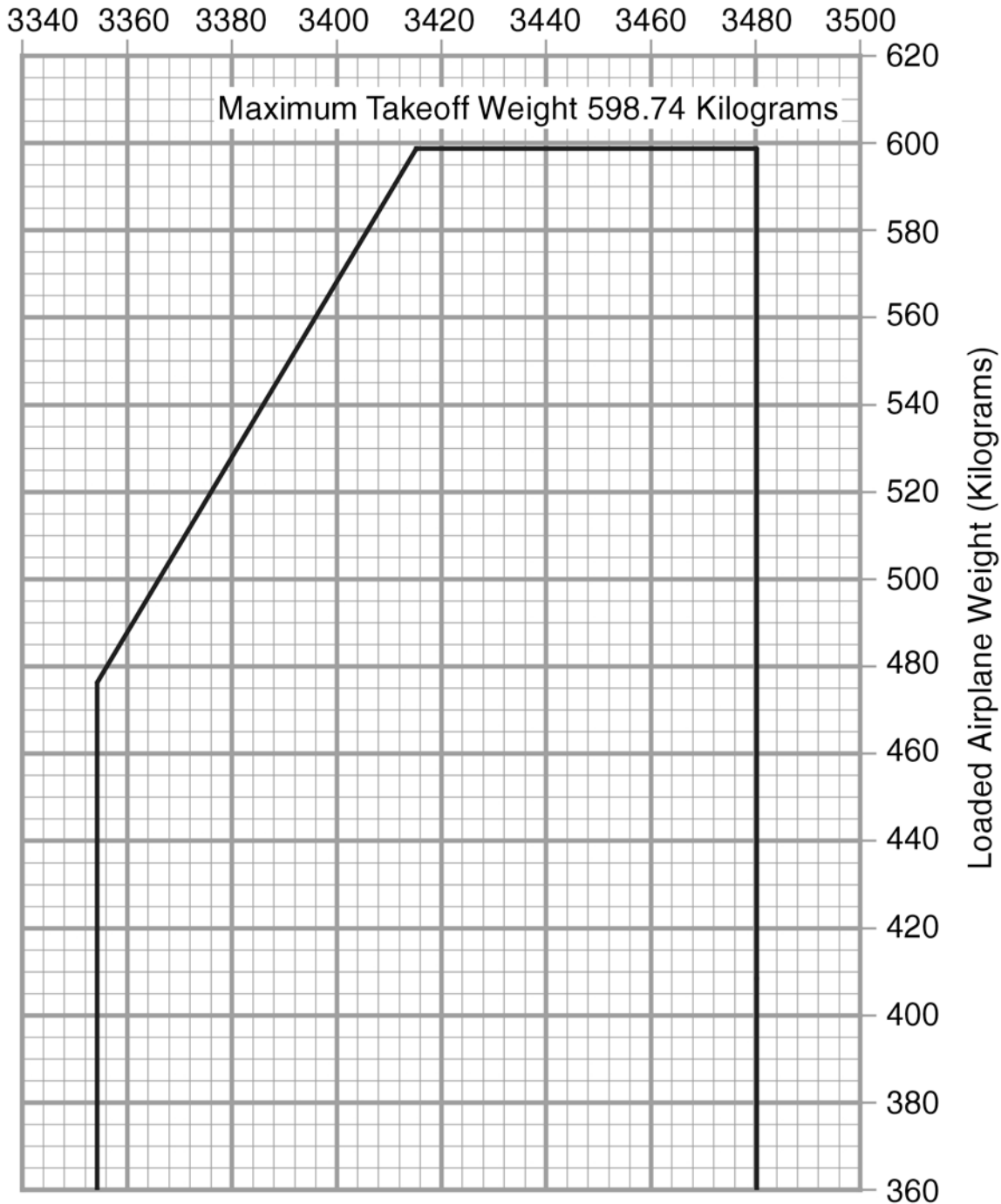

Figure 4-9 (Sheet 2)

PERFORMANCE

TABLE OF CONTENTS

	Page
Introduction	5-3
Use of Performance Charts	5-3
Sample Problem	5-4
Takeoff	5-5
Cruise	5-6
Fuel Required	5-7
Landing	5-9
Demonstrated Operating Temperature	5-9
Airspeed Calibration	5-10
Stall Speeds At 1320 Pounds	5-11
Short Field Takeoff Distance At 1320 Pounds	5-12
Short Field Landing Distance At 1320 Pounds	5-13
Maximum Rate Of Climb At 1320 Pounds	5-14
Time, Fuel And Distance To Climb At 1320 Pounds	5-15
Cruise Performance	5-16
Temperature Conversion Chart	5-17
Crosswind Component	5-18

INTRODUCTION

Performance data charts on the following pages are presented so that you may know what to expect from the airplane under various conditions and to facilitate the planning of flights in detail with reasonable accuracy. The data in the charts has been computed from actual flight tests with the airplane and engine in good condition and using average piloting techniques.

- Fuel flow data for cruise is based on the recommended lean mixture setting at all altitudes. Some indeterminate variables such as mixture leaning technique, fuel metering characteristics, engine and propeller condition, and air turbulence may account for variations of 10% or more in range and endurance. Therefore, it is important to utilize all available information to estimate the fuel required for the particular flight and to flight plan in a conservative manner.

USE OF PERFORMANCE CHARTS

- Performance data is presented in tabular form to illustrate the effect of different variables. Sufficiently detailed information is provided in the tables so that conservative values can be selected and used to determine the particular performance figure with reasonable accuracy.

SAMPLE PROBLEM

The following sample flight problem utilizes information from the various charts to determine the predicted performance data for a typical flight. Assume the following information has already been determined:

AIRPLANE CONFIGURATION:

Takeoff weight	1320 Pounds
Usable fuel	24.0 Gallons

TAKEOFF CONDITIONS:

Field pressure altitude	1500 Feet
Temperature	28°C (16°C Above Standard)
Wind component along runway	14 Knot Head Wind
Field length	3500 Feet

CRUISE CONDITIONS:

Total distance	260 Nautical Miles
Pressure altitude	5500 Feet
Temperature	20°C (16°C Above Standard)
Expected wind enroute	10 Knot Head Wind

LANDING CONDITIONS:

Field pressure altitude	2000 Feet
Temperature	25°C
Field length	3000 Feet

(Continued Next Page)

SAMPLE PROBLEM (Continued)

TAKEOFF

The takeoff distance chart, Figure 5-3, should be consulted, keeping in mind that distances shown are based on the short field technique. Conservative distances can be established by reading the chart at the next higher value of weight, altitude and temperature. For example, in this particular sample problem, the takeoff distance information presented for a weight of 1320 pounds, pressure altitude of 2000 feet and a temperature of 30°C should be used and results in the following:

■ Ground roll	860 Feet
■ Total distance to clear a 50-foot obstacle	1495 Feet

These distances are well within the available takeoff field length. However, a correction for the effect of wind may be made based on information presented in the note section of the takeoff chart. The correction for a 14 knot head wind is:

$$\frac{14 \text{ Knots}}{7 \text{ Knots}} \times 10\% = 20\% \text{ Decrease}$$

This results in the following distances, corrected for wind:

■ Ground roll, zero wind	860 Feet
■ Decrease in ground roll (860 feet X 20%)	<u>-172 Feet</u>
■ Corrected ground roll	688 Feet
■ Total distance to clear a 50-foot obstacle, zero wind	1495 Feet
■ Decrease in total distance (1495 feet X 20%)	<u>-299 Feet</u>
■ Corrected total distance to clear 50-foot obstacle	1196 Feet

(Continued Next Page)

SAMPLE PROBLEM (Continued)

CRUISE

The cruising altitude should be selected based on a consideration of trip length, winds aloft and the airplane's performance. A typical cruising altitude and the expected wind enroute have been given for this sample problem. However, the power setting selection for cruise must be determined based on several considerations. These include the cruise performance characteristics presented in Figure 5-7, the maximum rate of climb chart presented in Figure 5-5, and the time, fuel and distance to climb chart presented in Figure 5-6.

The cruise performance chart, Figure 5-7, is entered at 6000 feet pressure altitude and 20°C above standard temperature. These values most nearly correspond to the planned altitude and expected temperature conditions. The engine speed chosen is 2750 RPM, which results in the following:

■	Power	64%
■	True airspeed	108 Knots
■	Cruise fuel flow	6.0 GPH

(Continued Next Page)

SAMPLE PROBLEM (Continued)

FUEL REQUIRED

The total fuel requirement for the flight may be estimated using the performance information in Figure 5-6 and Figure 5-7. For this sample problem, the time, fuel and distance to climb may be determined from Figure 5-6 for maximum rate of climb. The difference between the values shown in the table for 5500 feet and 1500 feet results in the following:

■	Time:	6.5 Minutes
■	Fuel:	0.9 Gallons
■	Distance:	6.0 Nautical Miles

These values are for a standard temperature and are sufficiently accurate for most flight planning purposes. However, a further correction for the effect of temperature may be made as noted on the climb chart. The approximate effect of a nonstandard temperature is to increase the time, fuel and distance by 10% for each 10°C above standard temperature, due to the lower rate of climb. In this case, assuming a temperature 16°C above standard the correction would be:

$$\frac{16^{\circ}\text{C}}{10^{\circ}\text{C}} \times 10\% = 16\% \text{ Increase}$$

With this factor included, the fuel estimate would be calculated as follows:

■	Fuel to climb, standard temperature	0.9 Gallons
■	Increase due to non-standard temperature (0.9 X 16%)	<u>0.1 Gallons</u>
■	Corrected fuel to climb	1.0 Gallons

Using a similar procedure for the distance to climb results in 7 nautical miles.

The resultant cruise distance is:

■	Total distance	260 Nautical Miles
■	Climb distance	<u>-7 Nautical Miles</u>
■	Cruise distance	253 Nautical Miles

(Continued Next Page)

SAMPLE PROBLEM (Continued)

FUEL REQUIRED (Continued)

With an expected 10 knot head wind, the ground speed for cruise is predicted to be:

$$\begin{array}{r} 108 \text{ Knots} \\ -10 \text{ Knots} \\ \hline 98 \text{ Knots} \end{array}$$

Therefore, the time required for the cruise portion of the trip is:

$$\frac{253 \text{ Nautical Miles}}{98 \text{ Knots}} = 2.6 \text{ Hours}$$

The fuel required for cruise is:

$$2.6 \text{ hours} \times 6.0 \text{ gallons/hour} = 15.6 \text{ Gallons}$$

A 30-minute reserve requires:

$$\frac{30}{60} \times 6.0 \text{ gallons/hour} = 3.0 \text{ Gallons}$$

The total estimated fuel required is as follows:

Engine start, taxi, and takeoff	0.6 Gallons
Climb	1.0 Gallons
Cruise	15.6 Gallons
Reserve	<u>3.0 Gallons</u>
Total fuel required	20.2 Gallons

Once the flight is underway, ground speed checks will provide a more accurate basis for estimating the time enroute and the corresponding fuel required to complete the trip with ample reserve.

(Continued Next Page)

SAMPLE PROBLEM (Continued)

LANDING

A procedure similar to takeoff should be used for estimating the landing distance at the destination airport. Figure 5-4 presents landing distance information for the short field technique. The distances corresponding to 2000 feet and 30°C are as follows:

- Ground roll 760 Feet
- Total distance to clear a 50-foot obstacle 1485 Feet

A correction for the effect of wind may be made based on information presented in the note section of the landing chart, using the same procedure as outlined for takeoff.

DEMONSTRATED OPERATING TEMPERATURE

Satisfactory engine cooling has been demonstrated for this airplane with an outside air temperature 23°C above standard. This is not to be considered as an operating limitation. Reference should be made to Section 2 for engine operating limitations.

AIRSPEED CALIBRATION

NORMAL STATIC SOURCE ALL FLAP SETTINGS

CONDITIONS:

Power required for level flight or maximum power decent.

IAS	40	50	60	70	80	90	100	110	120	130	140	148
KCAS	43	52	61	71	80	89	98	108	117	126	135	143

Figure 5-1

STALL SPEED AT 1320 POUNDS

CONDITIONS:
 Power IDLE

MOST FORWARD CENTER OF GRAVITY

FLAP SETTINGS	ANGLE OF BANK							
	0°		30°		45°		60°	
	KIAS	KCAS	KIAS	KCAS	KIAS	KCAS	KIAS	KCAS
UP	41	44	45	47	50	52	61	62
10°	40	43	43	46	49	51	59	61
25°	38	41	41	44	46	49	56	58
FULL	37	40	40	43	45	48	55	57

NOTE

- Altitude loss during a stall recovery may be as much as 250 feet.
- KIAS values are approximate.

Figure 5-2

**SHORT FIELD TAKEOFF DISTANCE
AT 1320 POUNDS**

CONDITIONS:

Flaps 10°

Full Throttle Prior to Brake Release

Paved, Level, Dry Runway

Zero Wind

Lift Off: 50 KIAS

Speed at 50 ft: 55 KIAS

Press Altitude (ft)	0 °C		10 °C		20 °C		30 °C		40 °C	
	Ground	Dist. Over 50 ft	Ground	Dist. Over 50 ft	Ground	Dist. Over 50 ft	Ground	Dist. Over 50 ft	Ground	Dist. Over 50 ft
	Roll (ft)	Obs. (ft)	Roll (ft)	Obs. (ft)	Roll (ft)	Obs. (ft)	Roll (ft)	Obs. (ft)	Roll (ft)	Obs. (ft)
S. L.	570	1025	615	1100	665	1175	715	1260	770	1345
1000	620	1115	675	1195	725	1280	785	1370	845	1470
2000	680	1215	740	1300	795	1395	860	1495	930	1600
3000	750	1320	810	1420	875	1525	945	1635	1020	1750
4000	820	1440	890	1550	965	1665	1040	1790	1125	1920
5000	905	1575	980	1695	1060	1825	1150	1960	1240	2105
6000	995	1725	1080	1860	1170	2000	1265	2155	1370	2315
7000	1100	1895	1195	2040	1295	2200	1400	2370	1515	2550
8000	1215	2080	1320	2245	1430	2425	1550	2615	1675	2810

NOTE

- Short field technique as specified in Section 7.
- Prior to takeoff from fields above 3000 feet elevation, the mixture should be leaned to give maximum RPM in a full throttle, static runup.
- Decrease distances 10% for each 7 knots headwind. For operation with tail winds up to 10 knots, increase distances by 10% for each 1.5 knots.

Figure 5-3*

**SHORT FIELD LANDING DISTANCE
 AT 1320 POUNDS**

CONDITIONS:

Flaps FULL

Power IDLE

Paved, Level, Dry Runway

Maximum Braking

Zero Wind

Speed at 50 ft: 50 KIAS

Press Altitude (ft)	0 °C		10 °C		20 °C		30 °C		40 °C	
	Ground Roll (ft)	Dist. Over 50 ft Obs. (ft)	Ground Roll (ft)	Dist. Over 50 ft Obs. (ft)	Ground Roll (ft)	Dist. Over 50 ft Obs. (ft)	Ground Roll (ft)	Dist. Over 50 ft Obs. (ft)	Ground Roll (ft)	Dist. Over 50 ft Obs. (ft)
S. L.	635	1325	660	1355	685	1385	705	1415	730	1445
1000	660	1355	685	1385	710	1415	730	1450	755	1480
2000	685	1385	710	1420	735	1450	760	1485	785	1515
3000	710	1420	735	1455	760	1485	790	1520	815	1555
4000	735	1455	765	1490	790	1525	815	1560	845	1595
5000	765	1490	795	1525	820	1565	850	1600	875	1635
6000	795	1530	825	1565	850	1605	880	1640	910	1680
7000	825	1570	855	1605	885	1645	915	1685	945	1725
8000	855	1610	890	1650	920	1690	950	1730	980	1770

NOTE

- Short field technique as specified in Section 7.
- Decrease distances 10% for each 7 knots headwind. For operation with tail winds up to 10 knots, increase distances by 10% for each 1.5 knots.
- If landing with Flaps UP, increase the approach speed by 6 KIAS and allow for 20% longer distances.

Figure 5-4*

**MAXIMUM RATE OF CLIMB
AT 1320 POUNDS**

CONDITIONS:
Flaps UP
Full Throttle

Pressure Altitude - Feet	Climb Speed - KIAS	Rate of Climb - FPM			
		-20°C	0°C	20°C	40°C
Sea Level	62	1000	930	865	795
2000	62	875	810	745	675
4000	62	755	690	625	565
6000	62	630	570	510	445
8000	62	510	450	390	330
10,000	62	390	330	270	210
12,000	62	275	215	155	--

Figure 5-5*

TIME, FUEL AND DISTANCE TO CLIMB AT 1320 POUNDS

MAXIMUM RATE OF CLIMB

CONDITIONS:

Flaps UP

Full Throttle

Standard Temperature

Pressure Altitude Feet	Climb Speed KIAS	Rate of Climb FPM	From Sea Level		
			Time Minutes	Fuel Used Gallons	Distance NM
Sea Level	62	880	0	0.0	0
1000	62	825	1	0.2	1
2000	62	775	2	0.4	3
3000	62	720	4	0.6	4
4000	62	665	5	0.8	6
5000	62	615	7	1.1	7
6000	62	560	9	1.3	9
7000	62	505	10	1.6	12
8000	62	455	13	1.9	14
9000	62	400	15	2.2	17
10,000	62	345	18	2.5	20
11,000	62	295	21	2.9	24
12,000	62	240	25	3.4	29

NOTE

- Add 0.6 gallons of fuel for engine start, taxi and takeoff allowance.
- Increase time, fuel and distance by 10% for each 10 °C above standard temperature.
- Distances shown are based on zero wind.

Figure 5-6*

CRUISE PERFORMANCE

CONDITIONS:

1320 Pounds

Recommended Lean Mixture at All Altitudes

Press Altitude (ft)	RPM	20°C BELOW STANDARD TEMP			STANDARD TEMPERATURE			20°C ABOVE STANDARD TEMP		
		% BHP	KTAS	GPH	% BHP	KTAS	GPH	% BHP	KTAS	GPH
2000	2750	--	--	--	84	113	7.3	75	110	6.6
	2550	68	102	6.3	62	101	5.8	58	99	5.5
	2350	52	91	5.0	49	90	4.7	46	89	4.5
	2150	41	81	4.0	39	79	3.8	38	78	3.7
4000	2750	88	115	7.5	75	111	6.7	69	109	6.3
	2550	63	101	5.9	59	100	5.5	55	98	5.2
	2350	50	90	4.7	47	89	4.5	44	88	4.3
	2150	40	80	3.9	38	78	3.7	37	77	3.6
6000	2750	77	111	6.8	69	109	6.3	64	108	6.0
	2550	59	100	5.6	55	99	5.2	52	97	4.9
	2350	47	89	4.5	45	88	4.3	43	87	4.1
	2150	38	79	3.7	37	77	3.6	36	76	3.6
8000	2750	71	110	6.4	65	108	6.0	61	107	5.7
	2550	56	99	5.3	52	97	5.0	49	96	4.7
	2350	45	88	4.4	43	87	4.2	41	85	4.0
	2150	37	78	3.6	36	76	3.6	36	75	3.6
10,000	2650	59	103	5.5	55	101	5.2	52	100	4.9
	2450	48	92	4.6	45	91	4.4	43	90	4.2
	2250	39	82	3.9	38	80	3.7	38	79	3.7
12,000	2650	56	102	5.3	52	100	5.0	50	99	4.8
	2450	46	91	4.4	43	90	4.2	42	88	4.1
	2250	38	81	3.8	38	79	3.7	37	78	3.7

NOTE

- Maximum cruise power using recommended lean mixture is 75% MCP. Values above 75% MCP are shown for interpolation purposes only. Operations above 75% MCP must use full rich mixture.
- Cruise speeds are shown for an airplane equipped without speed fairings. With speed fairings, increase speeds shown by 2 knots.

Figure 5-7*

TEMPERATURE CONVERSION CHART

B3093

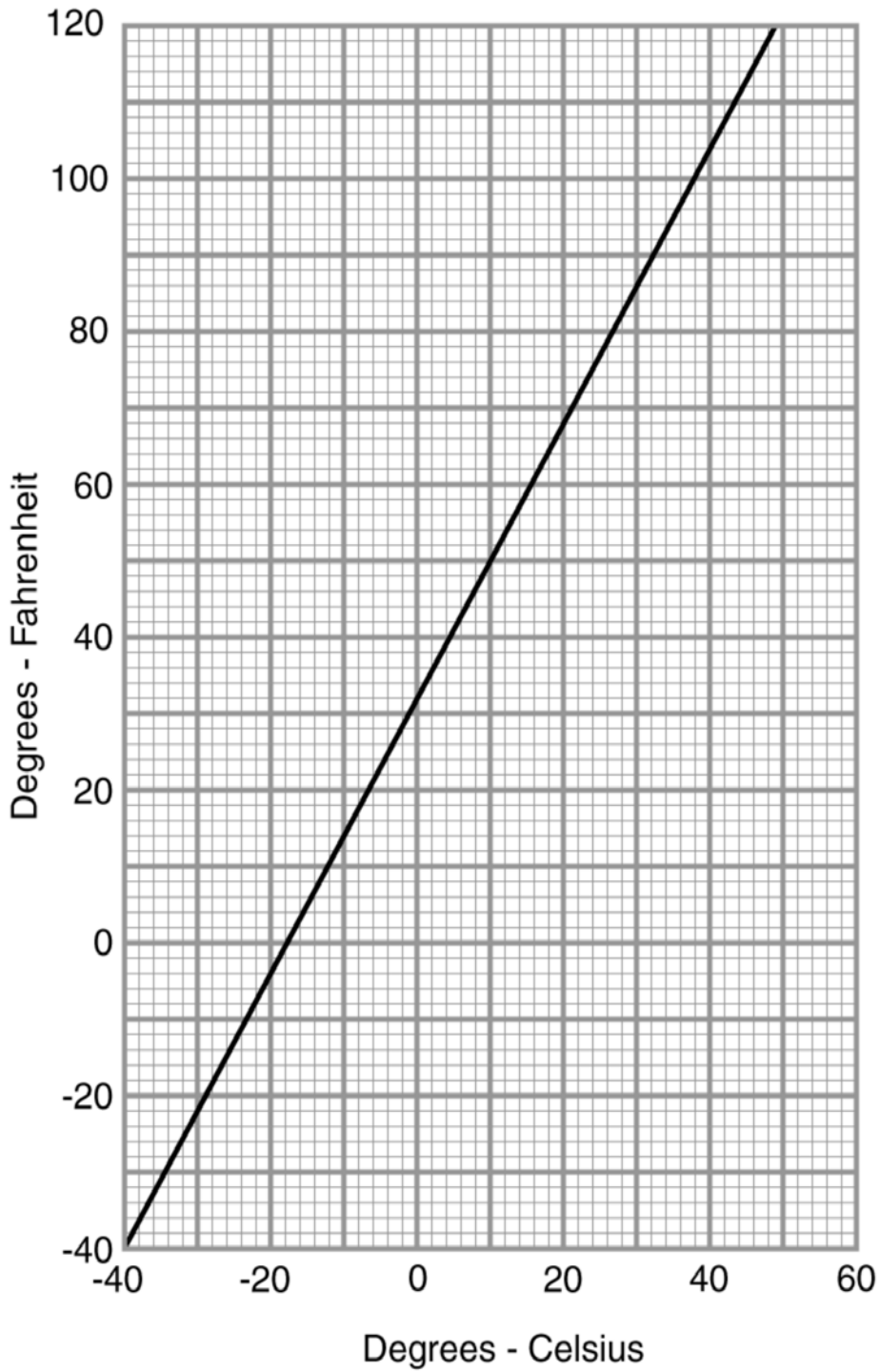
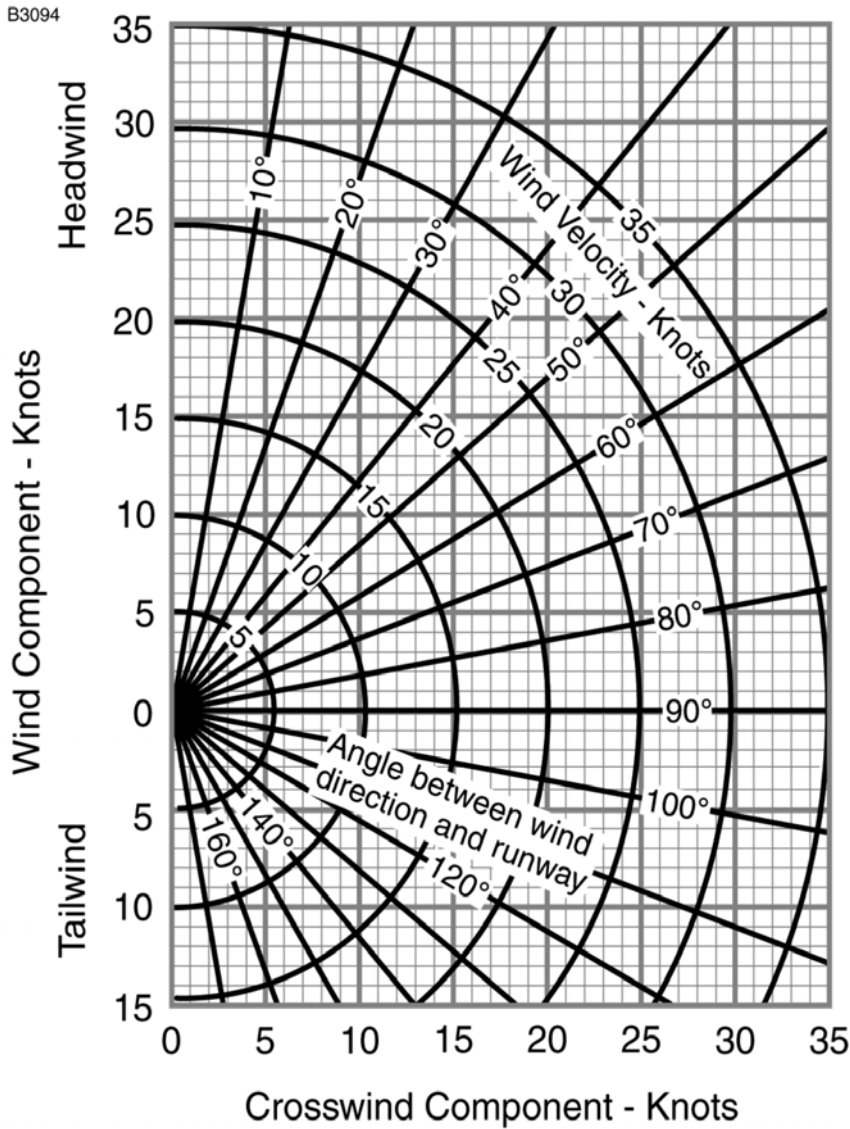

Figure 5-8

CROSSWIND COMPONENT



NOTE

Maximum demonstrated crosswind velocity is 12 knots (not a limitation).

Figure 5-9

EMERGENCY PROCEDURES

TABLE OF CONTENTS

	Page
Introduction	6-5
Airspeeds For Emergency Operations.....	6-5
EMERGENCY PROCEDURES	6-6
ENGINE FAILURES AND MALFUNCTIONS	6-6
Engine Failure During Takeoff Roll	6-6
Engine Failure Immediately After Takeoff	6-6
Engine Failure During Flight (Restart Procedures)	6-7
Oil PSI Indicator In Red Band Range (Red Digits)	6-7
Carb °F Indicator In Yellow Band Range (Yellow Digits).....	6-8
FORCED LANDINGS	6-9
Emergency Landing Without Engine Power	6-9
Precautionary Landing With Engine Power.....	6-10
Ditching	6-11
FIRES	6-12
During Start On Ground	6-12
Engine Fire In Flight	6-12
Electrical Fire or Cabin Fire In Flight.....	6-13
Wing Fire.....	6-14
ICING	6-15
Inadvertent Icing Encounter During Flight.....	6-15
ABNORMAL LANDINGS	6-17
Landing With Partial or No Flight Instrument Information	6-17
Landing With A Flat Main Tire.....	6-17
Landing With A Flat Nose Tire	6-18
Door Open in Flight.....	6-18
Landing With Door Open.....	6-18

(Continued Next Page)

TABLE OF CONTENTS (Continued)

	Page
ELECTRICAL POWER SUPPLY SYSTEM MALFUNCTIONS . . .	6-19
Loss Of All Electrical Power (Except PFD)	6-19
LOW VOLTS Annunciator Comes On or Volts Indication Below Green Band Range or Volts Less Than 12.5.	6-20
Volts Indication Above Green Band Range or Volts More Than 15	6-22
AIR DATA, ATTITUDE AND HEADING REFERENCE SYSTEM (ADAHRS) FAILURE	6-23
Red X - PFD or MFD Indicators (Airspeed, Altitude, Attitude, Horizontal Situation Indicator (HSI), or Engine Indicating System (EIS))	6-23
PFD/MFD DISPLAY MALFUNCTION OR FAILURE	6-24
PFD or MFD Display Black (No Information)	6-24
PFD or MFD Display Information Not Updating	6-25
Electric Pitch Trim Failure.	6-26

(Continued Next Page)

TABLE OF CONTENTS (Continued)

	Page
AMPLIFIED EMERGENCY PROCEDURES	6-27
Engine Failure	6-27
Maximum Glide	6-28
Forced Landings	6-29
Landing Without Elevator Control	6-30
Fires	6-30
Emergency Operation In Clouds	6-31
Executing A 180° Turn In Clouds (ADAHRS FAILED)	6-31
Emergency Descent Through Clouds (ADAHRS FAILED)	6-32
Recovery From Spiral Dive In The Clouds (ADAHRS FAILED)	6-33
Inadvertent Flight Into Icing Conditions	6-34
Spins	6-35
Rough Engine Operation Or Loss Of Power	6-36
Carburetor Icing	6-36
Spark Plug Fouling	6-36
Magnetos Malfunction	6-36
Idle Power Engine Roughness	6-37
Low Oil Pressure	6-37
Electrical Power Supply System Malfunctions	6-38
Excessive Rate Of Charge	6-38
Insufficient Rate Of Charge	6-39
Other Emergencies	6-40
Windshield Damage	6-40
G300 Failures	6-40

INTRODUCTION

Section 6 provides checklist and amplified procedures for coping with emergencies that may occur. Emergencies caused by airplane or engine malfunctions are extremely rare if proper preflight inspections and maintenance are practiced. Enroute weather emergencies can be minimized or eliminated by careful flight planning and good judgment when unexpected weather is encountered. However, should an emergency arise, the basic guidelines described in this section should be considered and applied as necessary to correct the problem. In any emergency situation, the most important task is continued control of the airplane and maneuver to execute a successful landing.

Emergency procedures associated with optional or supplemental equipment are found in Section 10, Supplements.

AIRSPEEDS FOR EMERGENCY OPERATIONS

ENGINE FAILURE AFTER TAKEOFF

Wing Flaps UP	70 KIAS
Wing Flaps 10° - FULL	65 KIAS

OPERATING MANEUVERING SPEED

1320 POUNDS	89 KIAS
1200 POUNDS	85 KIAS
1100 POUNDS	80 KIAS

MAXIMUM GLIDE 70 KIAS

PRECAUTIONARY LANDING WITH ENGINE POWER. 60 KIAS

LANDING WITHOUT ENGINE POWER

Wing Flaps UP	70 KIAS
Wing Flaps 10° - FULL	65 KIAS

EMERGENCY PROCEDURES

Procedures in the Emergency Procedures Checklist portion of this section shown in **bold faced** type are immediate action items which should be committed to memory.

ENGINE FAILURES AND MALFUNCTIONS

ENGINE FAILURE DURING TAKEOFF ROLL

1. **THROTTLE Control - IDLE (pull full out)**
2. **Brakes - APPLY**
3. Wing Flaps - RETRACT
4. MIXTURE Control - IDLE CUTOFF (pull full out)
5. MAGNETOS Switch - OFF
6. MASTER Switch (ALT and BAT) - OFF

ENGINE FAILURE IMMEDIATELY AFTER TAKEOFF

1. **Airspeed - 70 KIAS - Flaps UP**
65 KIAS - Flaps 10° - FULL
2. MIXTURE Control - IDLE CUTOFF (pull full out)
3. FUEL SHUTOFF Valve - OFF (pull full out)
4. MAGNETOS Switch - OFF
5. Wing Flaps - AS REQUIRED (FULL recommended)
6. MASTER Switch (ALT and BAT) - OFF (when landing is assured)
7. Land - STRAIGHT AHEAD
8. Doors - UNLATCH (just prior to touchdown)

NOTE

Both cabin doors are equipped with gas struts and should open automatically when unlatched. Delaying opening until just prior to touchdown will reduce cabin buffeting and wind noise. Non-emergency flight with doors open is prohibited.

(Continued Next Page)

ENGINE FAILURES AND MALFUNCTIONS (Continued)

ENGINE FAILURE DURING FLIGHT (Restart Procedures)

1. **Airspeed - 70 KIAS (best glide speed)**
2. **THROTTLE Control - IDLE (pull full out)**
3. **CARB HEAT Control Knob - ON (pull full out)**
4. **FUEL SHUTOFF Valve - ON (push full in)**
5. **MIXTURE Control - RICH (if restart has not occurred)**
6. **PRIMER - IN and LOCKED (if installed)**
7. **MAGNETOS Switch - BOTH (or START if propeller is stopped)**

NOTE

If the propeller is windmilling, engine will restart automatically within a few seconds. If propeller has stopped (possible at low speeds), turn MAGNETOS switch to START, advance throttle slowly from idle and lean the mixture from full rich as required to obtain smooth operation.

OIL PSI INDICATOR IN RED BAND RANGE (RED DIGITS)

1. OIL °F - CHECK

IF OIL °F ABOVE GREEN BAND RANGE OR OIL °F RISING (engine failure immanent)

2. Throttle Control - REDUCE POWER IMMEDIATELY
3. Airspeed - 70 KIAS (best glide speed)
4. Land as soon as possible (refer to EMERGENCY LANDING WITHOUT ENGINE POWER)

IF OIL °F WITHIN GREEN BAND RANGE

2. OIL °F - MONITOR
3. OIL PSI - MONITOR
4. Land as soon as practical (nearest suitable airport recommended)

(Continued Next Page)

ENGINE FAILURES AND MALFUNCTIONS (Continued)

CARB °F INDICATOR IN YELLOW BAND RANGE (YELLOW DIGITS)

1. ENGINE - MONITOR FOR ROUGHNESS AND/OR RPM LOSS

NOTE

Carb °F indicator in yellow band range indicates temperatures may support carb icing formation.

IF ENGINE ROUGHNESS AND/OR RPM LOSS IS DETECTED (CARB °F IN YELLOW BAND RANGE)

- 2. CARB HEAT Control Knob - ON (pull full out)**
- 3. THROTTLE Control - FULL (push full in)**
- 4. MIXTURE Control - LEAN (as required)**
- 5. CARB °F Indicator - CHECK**

IF ENGINE ROUGHNESS CONTINUES

- 6. CARB °F Indicator - MONITOR**
- 7. ALTITUDE - CONSIDER CHANGE (to warmer or drier air mass if terrain permits)**
- 8. Land as soon as practical.**

IF ENGINE ROUGHNESS IS NOT DETECTED (CARB °F ABOVE YELLOW BAND RANGE)

- 6. CARB °F Indicator - MONITOR**
- 7. CARB HEAT Control Knob - AS REQUIRED**
- 8. Continue flight as normal.**

FORCED LANDINGS

EMERGENCY LANDING WITHOUT ENGINE POWER

1. **Seats and Seat Belts - SECURE**
2. **Airspeed -70 KIAS - Flaps UP**
65 KIAS - Flaps 10° - FULL
3. **MIXTURE Control - IDLE CUTOFF (pull full out)**
4. **FUEL SHUTOFF Valve - OFF (pull full out)**
5. Radio - ALERT ATC or TRANSMIT MAYDAY ON 121.5 MHZ,
(give location, intentions and SQUAWK 7700)
6. MAGNETOS Switch - OFF
7. Wing Flaps - AS REQUIRED (FULL recommended)
8. MASTER Switch (ALT and BAT) - OFF (when landing is assured)
9. ELT - ACTIVATE
10. Doors - UNLATCH (just prior to touchdown)

NOTE

Both cabin doors are equipped with gas struts and should open automatically when unlatched. Delaying opening until just prior to touchdown will reduce cabin buffeting and wind noise. Non-emergency flight with doors open is prohibited.

11. Touchdown - SLIGHTLY TAIL LOW
12. Brakes - APPLY HEAVILY

(Continued Next Page)

FORCED LANDINGS (Continued)

PRECAUTIONARY LANDING WITH ENGINE POWER

1. Seats and Seat Belts - SECURE
2. Airspeed - 70 KIAS
3. Wing Flaps - 10° or 25°
4. Radio - ALERT ATC or TRANSMIT MAYDAY ON 121.5 MHZ,
(give location, intentions and SQUAWK 7700)
5. Selected Field - FLY OVER (noting terrain and obstructions)
6. Wing Flaps - FULL (on final approach)
7. Airspeed - 60 KIAS
8. MASTER Switch (ALT and BAT) - OFF (when landing assured)
9. ELT - ACTIVATE
10. Doors - UNLATCH (Just prior to touchdown)

NOTE

Both cabin doors are equipped with gas struts and should open automatically when unlatched. Delaying opening until just prior to touchdown will reduce cabin buffeting and wind noise. Non-emergency flight with doors open is prohibited.

11. Touchdown - SLIGHTLY TAIL LOW
12. MIXTURE Control - IDLE CUTOFF (pull full out)
13. MAGNETOS Switch - OFF
14. Brakes - APPLY HEAVILY

FORCED LANDINGS (Continued)

DITCHING

1. Radio - TRANSMIT MAYDAY on 121.5 MHz, (give location, intentions and SQUAWK 7700)
2. Heavy Objects (in baggage area) - SECURE OR JETTISON (if possible)
3. Seats and Seat Belts - SECURE
4. Wing Flaps - 25° or FULL
5. Power - ESTABLISH 300 FT/MIN DESCENT AT 60 KIAS

NOTE

If no power is available, approach at 70 KIAS with Flaps UP or at 65 KIAS with Flaps 10°.

6. Approach - High Winds, Heavy Seas - INTO THE WIND
Light Winds, Heavy Swells - PARALLEL TO SWELLS
7. ELT - ACTIVATE
8. Doors - UNLATCH (just prior to touchdown)

NOTE

Both cabin doors are equipped with gas struts and should open automatically when unlatched. Delaying opening until just prior to touchdown will reduce cabin buffeting and wind noise. Non-emergency flight with doors open is prohibited.

9. Touchdown - LEVEL ATTITUDE AT ESTABLISHED 300 FT/MIN DESCENT
10. Face - CUSHION AT TOUCHDOWN (with folded coat)
11. Airplane - EVACUATE THROUGH CABIN DOORS

FIRES

DURING START ON GROUND

1. **MAGNETOS Switch - START** (continue cranking to start the engine)

IF ENGINE STARTS

2. Power - 1800 RPM (for a few minutes)
3. Engine - SHUTDOWN (inspect for damage)

IF ENGINE FAILS TO START

2. **THROTTLE Control - FULL** (push full in)
3. **MIXTURE Control - IDLE CUTOFF** (pull full out)
4. **MAGNETOS Switch - START** (continue cranking)
5. **FUEL SHUTOFF Valve - OFF** (pull full out)
6. **MAGNETOS Switch - OFF**
7. **MASTER Switch (ALT and BAT) - OFF**
8. Engine - SECURE
9. Parking Brake - RELEASE
10. Fire Extinguisher - OBTAIN (have ground attendants obtain if not installed)
11. Airplane - EVACUATE
12. Fire - EXTINGUISH (using fire extinguisher, wool blanket, or dirt)
13. Fire Damage - INSPECT (repair or replace damaged components and/or wiring before conducting another flight)

ENGINE FIRE IN FLIGHT

1. **MIXTURE Control - IDLE CUTOFF** (pull full out)
2. **FUEL SHUTOFF Valve - OFF** (pull full out)
3. **MASTER Switch (ALT Only) - OFF**
4. Cabin Vents - OPEN (as needed)
5. **CABIN HEAT Control Knob - OFF** (push full in) (to avoid drafts)
6. Airspeed - 85 KIAS (If fire is not extinguished, increase glide speed to find an airspeed, within airspeed limitations, which will provide an incombustible mixture)
7. Forced Landing - EXECUTE (refer to EMERGENCY LANDING WITHOUT ENGINE POWER)

(Continued Next Page)

FIRES (Continued)

ELECTRICAL FIRE OR CABIN FIRE IN FLIGHT

1. **MASTER Switch (ALT and BAT) - OFF**

WARNING

OUTSIDE VISUAL REFERENCE MUST BE USED TO MAINTAIN SITUATIONAL AWARENESS. ALL FLIGHT INSTRUMENTS, RADIOS, AND PITCH TRIM WILL BE INOPERATIVE WHEN MASTER SWITCH IS TURNED OFF.

2. **Cabin Vents - CLOSED (to avoid drafts)**
3. **CABIN HEAT Control Knob - OFF (push full in) (to avoid drafts)**
4. **Fire Extinguisher - ACTIVATE (if available)**
5. **AVN MASTER Switch - OFF**
6. **All Other Switches (except MAGNETOS switch) - OFF**

IF FIRE HAS NOT BEEN EXTINGUISHED

7. **MASTER Switch (ALT and BAT) - ON**
8. **Rapid Descent - EXECUTE (Perform sideslip to rapidly lose altitude and shorten exposure time).**
9. **AVN MASTER Switch - ON**
10. **Radio - ALERT ATC or TRANSMIT MAYDAY ON 121.5 MHZ, (give location, intentions and SQUAWK 7700)**
11. **Forced Landing - EXECUTE (refer to PRECAUTIONARY LANDING WITH ENGINE POWER)**

NOTE

The G300 self-test and ADAHRS alignment may take several minutes to establish thus delaying display of flight instrument data. It may be necessary to execute landing without airspeed or altitude information.

(Continued Next Page)

FIRES (Continued)

ELECTRICAL FIRE OR CABIN FIRE IN FLIGHT (Continued)

IF FIRE HAS BEEN EXTINGUISHED AND ELECTRICAL POWER IS NECESSARY FOR CONTINUED FLIGHT TO NEAREST SUITABLE AIRPORT OR LANDING AREA

WARNING

AFTER THE FIRE EXTINGUISHER HAS BEEN USED, MAKE SURE THAT THE FIRE IS EXTINGUISHED BEFORE EXTERIOR AIR IS USED TO REMOVE SMOKE FROM THE CABIN.

7. Cabin Vents - OPEN (when sure that fire is completely extinguished)
8. CABIN HEAT Control Knob - ON (pull full out) (when sure that fire is completely extinguished)
9. Circuit Breakers - CHECK (for OPEN circuit(s), do not reset)
10. MASTER Switch (ALT and BAT) - ON
11. AVN MASTER Switch - ON
12. Land the airplane as soon as possible to inspect for damage.

WING FIRE

1. **LDG Light Switch - OFF**
2. **NAV Light Switch - OFF**
3. **STROBE Light Switch - OFF**

NOTE

Perform a sideslip to keep the flames away from the fuel tank and cabin.

4. Land as soon as possible.

ICING

INADVERTENT ICING ENCOUNTER DURING FLIGHT

1. **Turn back or change altitude to exit icing conditions.** Consider lateral or vertical flight path reversal to return to last "known good" flight conditions (to obtain an outside air temperature that is less conducive to icing). Maintain VFR flight.

WARNING

FAILURE TO ACT QUICKLY MAY RESULT IN AN UNRECOVERABLE ICING ENCOUNTER.

2. **CABIN HEAT Control Knob - ON (pull full out)**
3. **A/P DISC - PRESS (if installed)** (verify autopilot disengages and aural alert is heard)

WARNING

DO NOT ENGAGE AUTOPILOT WITH VISIBLE ICE ON AIRFRAME OR AFTER ENCOUNTERING ICING CONDITIONS.

4. Watch for signs of induction air filter icing and apply carburetor heat as required. Monitoring the G300 Carb °F Indicator may assist early detection. A loss of engine RPM could be caused by carburetor ice or ice blocking the air intake filter. Adjust the throttle as necessary to hold engine RPM. Adjust mixture as necessary for any change in power settings or if carburetor heat is used continuously.
5. Watch for ice accretion on pitot tube and signs of pitot-static icing. Airspeed and altimeter indications may become unreliable.
 - a. Attitude and Heading information will remain reliable in event of airspeed and altimeter failure. Use attitude indicator to monitor pitch and bank.
 - b. Reference GS (ground speed) in conjunction with GPS derived wind information to determine an approximate airspeed.

(Continued Next Page)

ICING (Continued)

INADVERTENT ICING ENCOUNTER DURING FLIGHT (Continued)

- c. Reference GPS ALTITUDE on MFD INFO page (if installed) or select G300 TERRAIN Profile page. GPS Altitude is provided by the white arrowhead on the left side of the TERRAIN Profile display.
- d. Navigate using Heading Strip, Lateral Deviation, and GPS moving map (GPS moving map and TERRAIN Profile can not be displayed at the same time).

NOTE

GPS information is not as accurate as barometric data but will provide an approximate value for comparison to pitot-static instruments or a back-up if barometric instruments become unreliable.

6. Plan a landing at the nearest airport. With an extremely rapid ice build-up, select a suitable off airport landing site.
7. With an ice accumulation of 0.25 inch (6.35mm) or more on the wing leading edges, be prepared for significantly higher power requirements, higher approach and stall speeds, and a longer landing roll. Gently pitch and yaw the airplane periodically to keep ice bridging on the controls to a minimum.
8. Leave wing flaps retracted. With a severe ice build-up on the horizontal tail, the change in wing wake airflow direction caused by wing flap extension could result in a loss of elevator effectiveness.
9. Perform a landing approach using a forward slip, if necessary, for improved visibility.
10. Approach at 65 to 70 KIAS (estimated 70 KIAS. if using GPS) depending upon the amount of ice accumulation.
11. Perform landing in level attitude.
12. Missed approaches should be avoided whenever possible because of severely reduced climb capability.

ABNORMAL LANDINGS

LANDING WITH PARTIAL OR NO FLIGHT INSTRUMENT INFORMATION

1. Transponder - Select Pressure Alt display using FUNC button (ADAHRS may be providing altitude information to transponder).
2. Selected Field - FLY OVER (noting terrain, obstructions, and any visual cues that may be used for speed references (i.e. traffic on nearby highway, etc))
3. Approach - NORMAL
4. Wing Flaps - AS REQUIRED (FULL recommended)
5. Speed - Use best pilot judgment and experience to reference speed cues such as flap extension forces, slipstream sounds, etc. Stall warning horn will function and provide approximately 5 knot stall warning.
6. Touchdown - NORMAL
7. Directional Control - MAINTAIN

NOTE

Without accurate speed information, landing may be made at faster than normal speeds. Gently apply brakes while continuing to “fly” the airplane during roll-out. Loss of directional control may result from locked brakes and skidding tires due to over braking.

LANDING WITH A FLAT MAIN TIRE

1. Approach - NORMAL
2. Wing Flaps - FULL
3. Touchdown - GOOD MAIN TIRE FIRST (hold airplane off flat tire as long as possible with aileron control)
4. Directional Control - MAINTAIN (using rudder and brake on good wheel as required)

ABNORMAL LANDINGS (Continued)

LANDING WITH A FLAT NOSE TIRE

1. Approach - NORMAL (choose longest runway if possible)
2. Wing Flaps - AS REQUIRED
 - a. 65 to 70 KIAS - Flaps UP - 10°
 - b. Below 65 KIAS - Flaps 10° - FULL
3. Touchdown - ON MAINS (tail slightly low)
4. Elevator - continue stick to full aft as airplane slows (hold nosewheel off the ground as long as possible)
5. When nosewheel touches down, maintain full up elevator as airplane slows to stop.
6. Directional Control - MAINTAIN (using full rudder control) Attempt to limit differential braking.
7. Braking - Use brakes only as needed to lessen chance of prop strike. Rolling drag of the flat nose tire will increase braking effect.

DOOR OPEN IN FLIGHT

WARNING

INTENTIONAL FLIGHT WITH DOOR(S) OPEN IS PROHIBITED.

1. CABIN DOOR - LEAVE OPEN (do not attempt to close)
2. THROTTLE Control - REDUCE (as necessary)
3. Airspeed - 80 KIAS (or less)
4. Seat Belts - CHECK (verify secure and tight)
5. Cabin - CHECK (stow loose materials)
6. Land as soon as practical.

LANDING WITH DOOR OPEN

1. Wing Flaps - AS REQUIRED
 - a. 65 to 70 KIAS - Flaps UP - 10°
 - b. Below 65 KIAS - Flaps 10° - FULL
2. Landing Approach - NORMAL (limit sideslip angle if possible)
3. Touchdown - NORMAL

ELECTRICAL POWER SUPPLY SYSTEM MALFUNCTIONS

LOSS OF ALL ELECTRICAL POWER (EXCEPT PFD)

1. MAIN CB RESET Switch - PRESS MOMENTARILY

IF ELECTRICAL POWER RESUMES NORMAL OPERATION

2. Continue flight and land as soon as practical.

IF ELECTRICAL POWER REMAINS INOPERATIVE (EXCEPT PFD)

2. Land as soon as possible.

NOTE

The PFD will be operating on the secondary battery only. The secondary battery is not a back-up battery. It is included in the electrical system to limit display presentation issues that might arise during the voltage drop which occurs during engine start. In good condition, the secondary battery may provide 5 to 10 minutes of PFD operation.

3. Prepare for total loss of electrical power and PFD. Refer to ABNORMAL LANDINGS, LANDING WITH PARTIAL OR NO FLIGHT INSTRUMENT INFORMATION

(Continued Next Page)

ELECTRICAL POWER SUPPLY SYSTEM MALFUNCTIONS (Continued)

LOW VOLTS ANNUNCIATOR COMES ON OR VOLTS INDICATION BELOW GREEN BAND RANGE OR VOLTS LESS THAN 12.5

NOTE

Volts indication below the green band range or less than 12.5 volts may occur during low RPM conditions with an electrical load on the system such as during a low RPM taxi. Under these conditions, the volts indication will increase into the green band range (12.5 - 15.0 volts) at higher RPM. The master switch need not be recycled since an overvoltage condition has not occurred to deactivate the alternator system.

1. AVN MASTER Switch - OFF

NOTE

Radio, Transponder, Pitch Trim, and options (MFD, Autopilot, and PS Intercom), if installed, will be inoperative with AVN MASTER Switch in the OFF position.

2. START/ALT Circuit Breaker - CHECK IN (if open, reset (close) circuit breaker. If circuit breaker opens again, do not reset)
3. MASTER Switch (ALT Only) - OFF
4. MASTER Switch (ALT Only) - ON
5. MAIN CB RESET Switch - PRESS MOMENTARILY
6. VOLTS - CHECK 13.5 Volts (minimum)
7. AMPS - CHECK CHARGING (positive)
8. AVN MASTER Switch - ON (only if VOLTS are 12.5 and AMPS are charging)

ELECTRICAL POWER SUPPLY SYSTEM MALFUNCTIONS (Continued)

IF VOLTS INDICATION REMAINS BELOW GREEN BAND RANGE OR LESS THAN 12.5 VOLTS

9. MASTER Switch (ALT Only) - OFF
10. Electrical Load - REDUCE as follows:
 - a. LDG Light Switch - OFF (use as required for landing)
 - b. NAV Light Switch - OFF
 - c. STROBE Light Switch - OFF
 - d. AVN MASTER Switch - OFF

NOTE

Radio, Transponder, Pitch Trim, and options (MFD, Autopilot, and PS Intercom), if installed, will be inoperative with AVN MASTER Switch in the OFF position.

11. Land as soon as practical.

NOTE

A fully charged battery in good condition should provide power under reduced load for 30 minutes.

(Continued Next Page)

ELECTRICAL POWER SUPPLY SYSTEM MALFUNCTIONS (Continued)

VOLTS INDICATION ABOVE GREEN BAND RANGE OR VOLTS MORE THAN 15

1. MASTER Switch (ALT Only) - OFF
2. Electrical Load - REDUCE as follows:
 - a. LDG Light Switch - OFF (use as required for landing)
 - b. NAV Light Switch - OFF
 - c. STROBE Light Switch - OFF
 - d. AVN MASTER Switch - OFF

NOTE

Radio, Transponder, Pitch Trim, and options (MFD, Autopilot, and PS Intercom), if installed, will be inoperative with AVN MASTER - OFF.

3. Land as soon as practical.

NOTE

A fully charged battery in good condition should provide power under reduced load for 30 minutes.

AIR DATA, ATTITUDE AND HEADING REFERENCE SYSTEM (ADAHRS) FAILURE

RED X - PFD OR MFD INDICATORS (AIRSPEED, ALTITUDE, ATTITUDE, HORIZONTAL SITUATION INDICATOR (HSI), OR ENGINE INDICATING SYSTEM (EIS))

1. ADAHRS Circuit Breaker - CHECK IN
 - a. If open, reset (close) circuit breaker. If circuit breaker opens again, do not reset.
 - b. If closed, pull (open) ADAHRS Circuit Breaker, and pull (open) SEC PWR Circuit Breaker (overhead Panel Light will go off) then reset (close) both circuit breakers
2. Affected Indicator (other than EIS) - RED-X STILL DISPLAYED
 - a. Reference GS (ground speed) in conjunction with GPS derived wind information to determine an approximate airspeed.
 - b. Select COMPASS ARC from G300 MAP SET-UP for approximate GPS derived heading information or monitor magnetic compass (if installed).
 - c. Reference GPS ALTITUDE on TERRAIN PROFILE page (GPS altitude is the white arrowhead on left side) or MFD INFO page (if installed) for approximate altitude.
 - d. Navigate using pilotage and GPS moving map if available.
 - e. Land as soon as possible.
3. EIS Engine Indicating System - RED-X STILL DISPLAYED
 - a. If only the EIS is RED X (no other PFD or MFD RED X is present), continue monitoring. Non-emergency full throttle operation should be limited to prevent engine overspeed or exceeding temperatures. Descents should be made at idle with carburetor heat applied.
 - b. Land as soon as possible.
4. Affected Indicator - RED-X HAS CLEARED (indicator normal)
5. Land as soon as practical.

PFD/MFD DISPLAY MALFUNCTION OR FAILURE

PFD OR MFD DISPLAY BLACK (NO INFORMATION)

WARNING

DO NOT SELECT G300 MANUAL INTENSITY MODE. BACKLIGHT INTENSITY SHOULD REMAIN IN THE AUTOMATIC MODE TO PREVENT AN UNREADABLE DISPLAY CONDITION.

1. PANEL LIGHTS Control Knob - FULL BRIGHT (full clockwise rotation)
2. PFD/MFD Circuit Breaker - CHECK IN
 - a. If open, reset (close) circuit breaker. If circuit breaker opens again, do not reset.
 - b. If closed, pull (open) PFD/MFD Circuit Breaker, and pull (open) SEC PWR Circuit Breaker (overhead Panel Light will go off) then reset (close) both circuit breakers
3. Affected Display - Continued BLACK Screen (No information displayed) - Use other display (if installed).
 - a. Transponder - Select Pressure Alt display using FUNC button (ADAHRS may be providing altitude information to transponder)
 - b. Navigate using pilotage and magnetic compass (if installed) to nearest suitable landing site.
 - c. Land as soon as possible. Refer to LANDING WITH PARTIAL OR NO INSTRUMENTATION INFORMATION.
4. Affected Display - NORMAL SCREEN
 - a. Land as soon as practical.

(Continued Next Page)

PFD/MFD DISPLAY MALFUNCTION OR FAILURE

(Continued)

PFD OR MFD DISPLAY INFORMATION NOT UPDATING

1. Pull (open) the following circuit breakers:
 - a. ADAHRS Circuit Breaker - OPEN
 - b. PFD/MFD Circuit Breaker - OPEN
 - c. SEC PWR Circuit Breaker - OPEN (overhead panel light will go off)
2. Reset (close) all three circuit breakers
 - a. ADAHRS Circuit Breaker - CLOSE
 - b. PFD/MFD Circuit Breaker - CLOSE
 - c. SEC PWR Circuit Breaker - CLOSE
3. Affected Display(s) - NOT UPDATING (use other display (if installed)).
 - a. Transponder - Select Pressure Altitude display using FUNC button (ADAHRS may be providing altitude information to transponder).
 - b. Navigate using pilotage and magnetic compass (if installed) to nearest suitable landing site.
 - c. Land as soon as possible. Refer to LANDING WITH PARTIAL OR NO INSTRUMENTATION INFORMATION
4. Affected Display - NORMAL SCREEN
 - a. Land as soon as practical.

ELECTRIC PITCH TRIM FAILURE

1. AVN MASTER Switch - VERIFY ON
2. TRIM/AP Circuit Breaker - CHECK IN
 - a. If open, reset (close) circuit breaker. If circuit breaker opens again, do not reset.
 - b. If closed, pull (open) TRIM/AP Circuit Breaker, then reset (close) the circuit breaker.

ELECTRIC PITCH TRIM SYSTEM REMAINS INOPERATIVE

3. Reduce pitch control forces by changing speed or flap configuration (within airspeed limitations).
4. CRUISE - Consider range reduction and destination change if cruise speed is reduced by flap speed limitations.
5. APPROACH - Establish stabilized approach using normal speeds is preferred. This may include change of destination for longer runway.
6. LANDING WITH FAILED TRIM - Consider making Flaps UP landing if pitch control force increases uncomfortably when lowering landing flaps.
7. Land as soon as practical.

ELECTRIC PITCH TRIM SYSTEM RESUMES NORMAL OPERATION

3. Land as soon as practical.

AMPLIFIED EMERGENCY PROCEDURES

The following Amplified Emergency Procedures provide additional information beyond that in the Emergency Procedures Checklists portion of this section. These procedures also include information not readily adaptable to a checklist format, and material to which a pilot could not be expected to refer in resolution of a specific emergency. This information should be reviewed in detail prior to flying the airplane, as well as reviewed on a regular basis to keep pilot's knowledge of procedures fresh.

ENGINE FAILURE

If an engine failure occurs during the takeoff roll, stop the airplane on the remaining runway. Those extra items on the checklist will provide added safety after a failure of this type.

If an engine failure occurs immediately after takeoff, in most cases, the landing should be planned straight ahead with only small changes in direction to avoid obstructions. Altitude and airspeed are seldom sufficient to execute the 180° gliding turn necessary to return to the runway. The checklist procedures assume that adequate time exists to secure the fuel and ignition systems prior to touchdown.

After an engine failure in flight, the most important task is to continue flying the airplane. The best glide speed, as shown in Figure 6-1, should be established as quickly as possible. While gliding toward a suitable landing area, an effort should be made to identify the cause of the failure. If time permits, an engine restart should be attempted as shown in the checklist. If the engine cannot be restarted, a forced landing without power must be completed.

MAXIMUM GLIDE

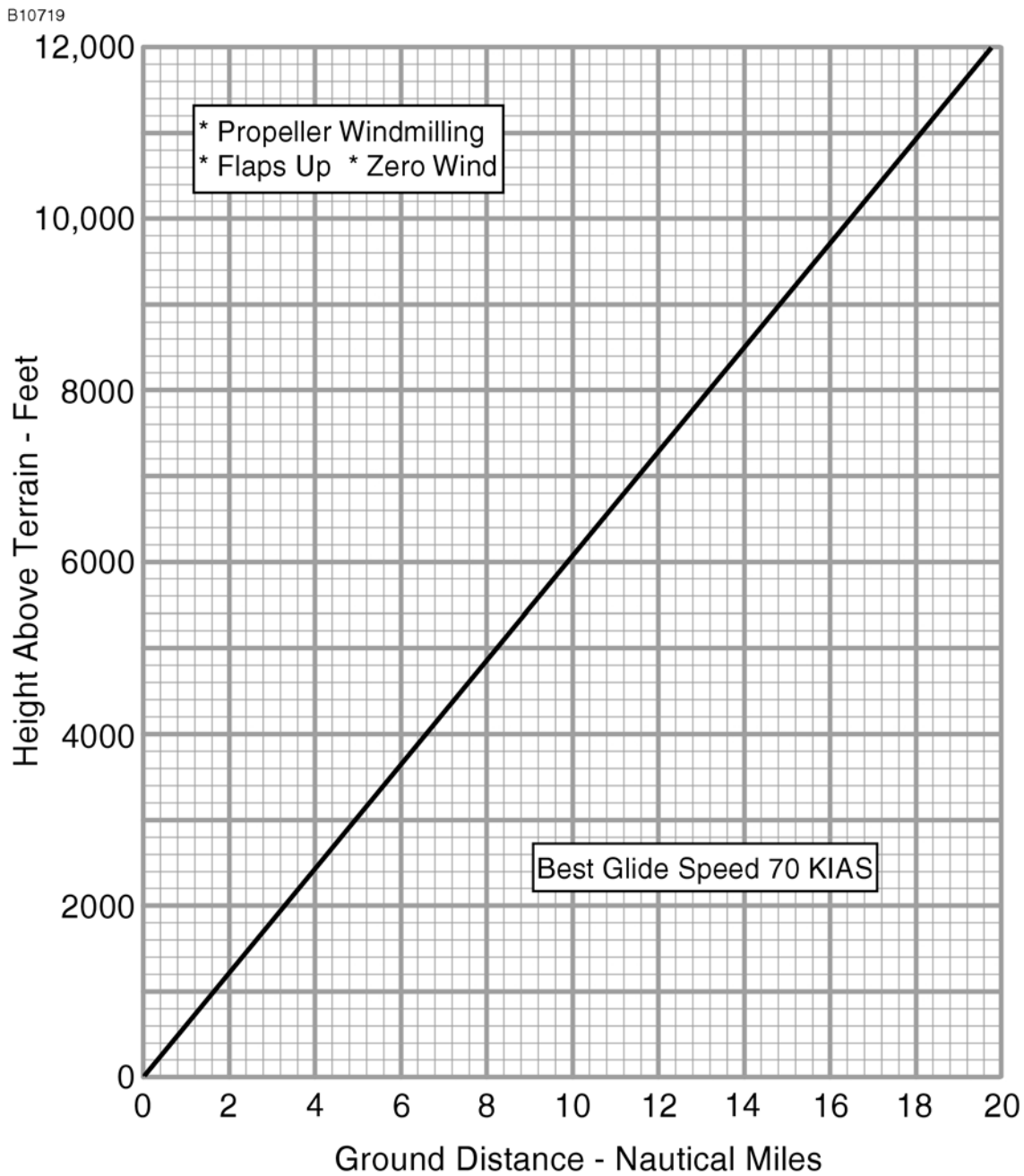

Figure 6-1

FORCED LANDINGS

If all attempts to restart the engine fail and a forced landing is imminent, select a suitable field and prepare for the landing as discussed under the Emergency Landing Without Engine Power checklist. Transmit Mayday message on 121.5 MHz giving location, intentions and squawk 7700.

Before attempting an off airport landing with engine power available, one should fly over the landing area at a safe, but low altitude, to inspect the terrain for obstructions and surface conditions, proceeding as discussed in the Precautionary Landing With Engine Power checklist.

Prepare for ditching by securing or jettisoning heavy objects located in the baggage area and collect folded coats for protection of occupants' face at touchdown. Transmit Mayday messages on 121.5 MHz giving location, intentions and squawk 7700. Avoid a landing flare because of the difficulty in judging height over a water surface. The checklist assumes the availability of power to make a precautionary water landing. If power is not available, use of the airspeeds noted with minimum flap extension will provide a more favorable attitude for a power off ditching.

In a forced landing situation, DO NOT turn off the MASTER switch (BAT side) or AVN MASTER switch before the landing is assured unless specifically instructed by the emergency procedure checklist. Premature deactivation of these switches will disable all airplane electrical systems. Note however there are specific emergency procedures (such as Electrical Fire) which do require the MASTER switch (ALT side) to be turned off. Exercise caution when performing these procedures to ensure that only the ALT side is selected off.

Before completing a forced landing, especially in remote and mountainous areas, activate the ELT by pressing the ELT ON switch located on the right instrument panel. For complete information on ELT operation, refer to Section 10, Supplements.

LANDING WITHOUT ELEVATOR CONTROL

Using throttle and electric elevator trim switch, trim for horizontal flight at 55-60 KIAS with flaps 25° selected. Then **do not change the elevator trim or the flap setting**; control the glide angle by making small changes in power.

Power changes should be made slowly and smoothly. The electric elevator trim is powerful. It is best to bump, or pulse, the trim switch to make changes. Holding the trim switch can result in over trimming and may start a Pilot Induced Oscillation (PIO) condition resulting in chasing the trim. If this occurs, it is best to let the airplane stabilize then start again by just bumping the trim switch.

When in the flare, the elevator trim switch should be pulsed aft toward the full-nose-up position at the same time slowly reducing power so that the airplane is rotated to a slightly nose-above-the-horizon attitude for touchdown. During the landing flare or round-out, the nose will come down when power is reduced and the airplane may touch down on the nosewheel before the main wheels. Maintain directional control and close the throttle at touchdown.

FIRES

Although engine fires are extremely rare in flight, if a fire is encountered, the steps of the appropriate checklist should be followed. After completion of the checklist procedure, execute a forced landing. Do not attempt to restart the engine. The first sign of an electrical fire is usually the smell of burning insulation. The checklist procedure for electrical fires calls for electrical power to be turned off. All flight instruments and navigation will be lost at this time. The checklist procedure should result in the elimination of the fire. When the fire is extinguished, electrical power may be turned on to those systems not involved. Navigation and flight information, if unaffected, should be reposted to instruments within 1-2 minutes. If the fire is not extinguished, a rapid descent should be initiated and the electrical system turned back on. This may provide airspeed and altitude data in preparation for a forced landing.

EMERGENCY OPERATION IN CLOUDS

The Model 162 Skycatcher is not equipped or certified for IFR flight. The following instructions assume that the pilot is not very proficient at instrument flying and is flying the airplane without the autopilot engaged.

EXECUTING A 180° TURN IN CLOUDS (ADAHRS FAILED)

Upon inadvertently entering the clouds, an immediate turn to reverse course and return to VFR conditions should be made. With ADAHRS FAILED, magnetometer (magnetic) heading information is not available. The G300 map display should be configured with the COMPASS ARC from the MAP SET-UP menu. The COMPASS ARC will provide GPS derived heading information on the moving map display. GPS derived heading information is not as accurate as magnetic heading; it will provide a means of situational awareness and the moving map can provide navigation. Other GPS information such as track (TRK), etc. are also available with a functioning G300 system. Refer to the G300 Pilot's Guide.

If the optional magnetic compass is installed, the magnetic compass maybe used in place of the G300 compass arc. The magnetic compass will be subject to normal magnetic compass A.N.D.S. variations during maneuvering.

(Continued Next Page)

EMERGENCY OPERATION IN CLOUDS (Continued)

EMERGENCY DESCENT THROUGH CLOUDS (ADAHRS FAILED)

When returning to VFR flight after a 180° turn is not practical, a descent through the clouds to VFR conditions below may be appropriate. If possible, obtain an ATC assistance and clearance for an emergency descent through the clouds.

Before descending into the clouds, prepare for a stabilized descent as follows:

1. Reference optional magnetic compass (if installed) or select G300 map with COMPASS ARC from MAP SET-UP menu for GPS derived approximate heading information on moving map display.
2. If MFD is installed, select the INFO page and reference the GPS ALTITUDE. GPS ALTITUDE is not the same as barometric altitude but it will give an altitude approximation.
3. TERRAIN - Select G300 TERRAIN - ON. If RED terrain warning is issued, apply full power and climb at 58 KIAS estimated. Stall warning will provide approximate 5 knot stall warning margin.
4. Monitor Ground Speed (GS) - GPS derived GS in combination with GPS derived wind vector information will allow approximation of airspeed.
5. MIXTURE Control - RICH (push full in)
6. CARB HEAT Control Knob - ON (pull full out)
7. THROTTLE Control - REDUCE (1700 - 1800 RPM)
8. Approximate Airspeed - 70 - 75 Knots (estimate airspeed from GS and wind vector data)
9. Elevator Trim - ADJUST (as required)
10. Maintain descent - procedure will provide 500 TO 800 FT/MIN descent rate.
11. Upon breaking out of clouds, resume normal cruising flight.

(Continued Next Page)

EMERGENCY OPERATION IN CLOUDS (Continued)

RECOVERY FROM SPIRAL DIVE IN THE CLOUDS (ADAHRS FAILED)

ADAHRS FAILURE

If a spiral is entered while in the clouds, continue as follows:

1. THROTTLE Control - IDLE (pull full out)
2. Remove feet from rudder pedals.
3. Stop turn by carefully leveling the wings using aileron control while referencing COMPASS ARC or optional magnetic compass (if installed) and moving map for heading and turn information.
4. Cautiously apply elevator back pressure to slowly reduce airspeed to approximately 70 KIAS. Monitor speed and do not reduce airspeed below 70 KIAS. Slowly advance throttle to approximate 1700-1800 RPM as speed reaches 70-75 Knots.
5. Elevator Trim - ADJUST (maintain 70-75 KIAS glide speed)
6. Use aileron control to maintain wings level and constant heading.
7. CARB HEAT Control Knob - ON (pull full out)
8. Clear engine occasionally, but avoid using enough power to disturb the trimmed glide.
9. Resume EMERGENCY DESCENT THROUGH THE CLOUDS procedure.
10. Upon breaking out of clouds, resume normal cruising flight.

INADVERTENT FLIGHT INTO ICING CONDITIONS

Flight into icing conditions is prohibited and extremely dangerous. While an inadvertent encounter with these conditions can be resolved using the checklist procedures, the best action is to turn back or change altitude immediately to escape icing conditions.

Watch for signs of pitot-static icing and ice accretion on the unheated pitot tube. If airspeed and altimeter indications become unreliable, GPS derived flight information can provide approximate values for back-up. GPS derived ground speed (GS) and GPS ALTITUDE on the MFD INFO page (if installed) may be used for comparison to barometric instruments. GPS ALTITUDE information also replaces barometric altitude in the TERRAIN Page PROFILE window (indicated by a white arrowhead) when the ADAHRS is inoperative.

In the event of an icing encounter, an unexplained loss of engine power could be caused by carburetor ice or ice blocking the air intake filter. Should this happen, apply full carburetor heat and adjust throttle to obtain maximum RPM. In some instances, the throttle may need to be reduced for maximum power. The mixture should then be adjusted, as required, to obtain maximum RPM. The G300 CARB °F indicator should be monitored during carb heat application to ensure carb temperature rises. Refer to the CARBUETOR ICING AMPLIFIED EMERGENCY PROCEDURE section.

Maximum cabin heat should be applied, by pulling the CABIN HEAT Control Knob to the full out position, in an attempt to clear ice from the windshield. GPS moving map navigation may assist if ice creates a loss of visibility. If available, select G300 TERRAIN - ON for additional altitude and obstacle awareness during reduced visibility. Use of a forward slip can improve forward and over-the-nose landing visibility inhibited by windshield ice. FLAPS should NOT be used for landing if airframe ice is present.

The autopilot, if installed, should be disconnected at first indication of airframe icing and remain disconnected after any icing encounter due to the possibility of unseen residual ice on the airframe.

SPINS

Should an inadvertent spin occur, the following recovery procedure should be used:

- 1. IMMEDIATELY RETARD THROTTLE TO IDLE POSITION.**
- 2. PLACE AILERONS IN NEUTRAL POSITION.**
- 3. APPLY AND HOLD FULL RUDDER OPPOSITE TO THE DIRECTION OF ROTATION AND MOVE CONTROL STICK BRISKLY FORWARD FAR ENOUGH TO BREAK THE STALL.**
Full down elevator may be required at aft center of gravity loadings to assure optimum recoveries.
- 4. HOLD THESE CONTROL INPUTS UNTIL ROTATION STOPS.**
Premature relaxation of the control inputs may extend the recovery.
- 5. AS ROTATION STOPS, NEUTRALIZE RUDDER, WINGS LEVEL, FLAPS UP AND MAKE A SMOOTH RECOVERY FROM THE RESULTING DIVE. AVOID OVERSTRESSING AND OVERSPEEDING THE AIRFRAME.**

NOTE

If the rate of the spin makes determining the direction of rotation difficult, the magenta turn rate trend vector in the heading strip over the PFD Attitude Indicator will show the rate and direction of the turn. The HSI compass card will rotate in the opposite direction. Hold full rudder opposite the direction of the turn indicated by the turn rate trend vector.

ROUGH ENGINE OPERATION OR LOSS OF POWER

CARBURETOR ICING

A gradual loss of RPM and eventual engine roughness may result from the formation of carburetor ice. To clear the ice, apply full throttle and pull the CARB HEAT control knob full out until the engine runs smoothly; then reduce carburetor heat and readjust throttle as necessary. Monitor the G300 CARB °F indicator to verify the carburetor temperature rises out of the amber caution range. If conditions require the continued use of carburetor heat in cruise flight, use the minimum amount of heat necessary to prevent ice from forming and lean the mixture for smoothest engine operation. The G300 CARB °F indicator provides advisory information but does not replace the need to monitor engine condition and adjust carburetor heat or mixture as needed for safe engine performance.

SPARK PLUG FOULING

A slight engine roughness in flight may be caused by one or more spark plugs becoming fouled by carbon or lead deposits. This may be verified by turning the MAGNETOS switch momentarily from BOTH to either L or R position. An obvious power loss in single magneto operation is evidence of spark plug or magneto trouble. Leaning the mixture to the recommended lean setting for cruising flight may resolve a spark plug fouling issue. If the problem does not clear up in several minutes, determine if a richer mixture setting will produce smoother operation. If not, proceed to the nearest airport for repairs using the BOTH position of the MAGNETOS switch unless extreme roughness makes the use of a single MAGNETO position necessary.

MAGNETO MALFUNCTION

Sudden engine roughness or misfiring is usually a sign of a magneto problem. Changing the MAGNETOS switch from BOTH to the L and R switch positions will identify which magneto is malfunctioning. Select different power settings and enrichen the mixture to determine if continued operation on BOTH magnetos is possible. If not, change to the good magneto and continue to the nearest airport for repairs.

(Continued Next Page)

ROUGH ENGINE OPERATION OR LOSS OF POWER

(Continued)

IDLE POWER ENGINE ROUGHNESS

An excessively rich idle fuel flow may cause low speed engine roughness during flight. During most in-flight low engine speeds (power off stalls, approach to landing, etc.), the mixture control is normally in the full-rich position. However, to improve engine roughness during low engine speeds while in flight, you should rotate the vernier mixture control to lean of fuel mixture. You may also have to lean the fuel mixture if this low engine speed results in power loss and you need to restart the engine during flight. In all cases, you should land the airplane at the nearest airport for repairs if low speed engine roughness requires you to adjust the fuel mixture control to improve engine operation.

LOW OIL PRESSURE

If the low oil pressure indicator (OIL PSI) turns red, and oil temperature indicator (OIL °F) remains normal, it is possible that the oil pressure sending unit or relief valve is malfunctioning. Land at the nearest airport to determine the source of the problem.

If a total loss of oil pressure and a rise in oil temperature occur at about the same time, it could mean that the engine is about to fail. Reduce power immediately and select a field suitable for a forced landing. Use only the minimum power necessary to reach the landing site.

ELECTRICAL POWER SUPPLY SYSTEM MALFUNCTIONS

Malfunctions in the electrical power supply system can be detected through regular monitoring of the main battery ammeter (AMPS) and the electrical bus voltmeter (VOLTS); however, the cause of these malfunctions is usually difficult to determine. A broken alternator shaft, excessive brush wear, or an internal wiring issue is most likely the cause of alternator failures, although other factors could cause the problem. Problems of this nature constitute an electrical emergency and should be dealt with immediately. Electrical power malfunctions usually fall into two categories: excessive rate of charge and insufficient rate of charge. The following paragraphs describe the recommended remedy for each situation.

EXCESSIVE RATE OF CHARGE

After engine starting and heavy electrical usage at low engine speeds, such as extended taxiing, the battery condition may be low enough to accept above normal charging during the initial part of a flight. However, after thirty minutes of cruising flight, the main battery ammeter (AMPS) should be indicating less than 5 amps of charging (+) current. If the charging current remains above this value on a long flight, the battery electrolyte could overheat and evaporate.

Electronic components in the electrical system can be adversely affected by higher than normal voltage. The built-in overvoltage protection circuit will automatically disconnect the alternator if the charge voltage increases to more than 16.5 volts. If the overvoltage sensor circuit does not operate correctly, as shown by voltage more than 16.5 volts on the electrical bus voltmeter, the MASTER switch ALT section should be set to the OFF position. Unnecessary electrical equipment should be de-energized and the flight terminated as soon as practical.

If excessive rate of charge is indicated but the electrical bus voltmeter indicates less than 15 volts, no immediate action is required. Continue monitoring and land as soon as practical.

(Continued Next Page)

ELECTRICAL POWER SUPPLY SYSTEM MALFUNCTIONS (Continued)

INSUFFICIENT RATE OF CHARGE

When the overvoltage circuit, or other fault, opens the alternator (START/ALT) circuit breaker and de-energizes the alternator, a discharge (-) current will be shown on the main battery ammeter (AMPS) and the red LOW VOLTS annunciator will be displayed on the PFD. The Alternator Internal Control Unit (AICU) can de-energize the alternator due to minor disturbances in the electrical system, resulting in a nuisance opening of the START/ALT circuit breaker. If this happens, an attempt should be made to energize the alternator system.

To energize the alternator system

1. MASTER Switch (ALT Only) - OFF
2. START/ALT Circuit Breaker - CHECK IN
3. MASTER Switch (ALT Only) - ON

If the problem was a minor AICU disturbance in the electrical system, normal main battery charging will start. A charge (+) current will be shown on the main battery ammeter (AMPS) and the LOW VOLTS annunciator will go off.

If the red LOW VOLTS annunciator is displayed and a discharge (-) current is still shown on the AMPS Indicator, there is an alternator system problem. Do not repeat steps to energize the alternator system. Decrease the electrical load on the battery by de-energizing nonessential electrical equipment and avionics (consider exterior lights and radio equipment) because the battery can supply the electrical system for only a short time. Reduce electrical load as soon as possible to extend the life of the battery for landing. Land as soon as practical.

OTHER EMERGENCIES

WINDSHIELD DAMAGE

If a bird strike or other incident should damage the windshield in flight to the point of creating an opening, a significant loss in performance may be expected. Decrease airspeed and set power as necessary to maintain best glide speed (70 KIAS) to minimize stress on windshield and airframe structure. If airplane performance or other adverse conditions prevent landing at an airport, prepare for an off airport landing in accordance with the PRECAUTIONARY LANDING WITH ENGINE POWER or DITCHING checklists.

G300 FAILURES

The Garmin G300 system provides all flight and engine instrument information via the Air Data Attitude and Heading Reference System (ADAHRS) unit. Individual sensors within the ADAHRS unit provide air and flight data information as well as serve as the central gateway for the engine data displayed on the Primary Flight Display (PFD) and optional Multi-Function Display (MFD).

Failure of the ADAHRS unit or the individual sensors may leave only GPS derived flight data for situational awareness and navigation. The pilot should be thoroughly familiar with the G300 operation, page and information location, and methods of accessing the GPS flight data before beginning any flight in the Model 162 Skycatcher. It is recommended that the pilot step through each of the G300 emergency procedures in the Emergency Procedures Checklist for familiarization before operating the aircraft.

Failure of the G300 PFD display will cause an automatic reversion of the PFD display to the MFD display (if installed). Failure of the PFD without an installed MFD display will leave the pilot to rely largely on external cues for pilotage and navigation. The Emergency Procedures Checklist contains suggestions for managing a successful PFD failure and landing. It is recommended that the pilot become familiar with this checklist before operating the airplane.

NORMAL PROCEDURES

TABLE OF CONTENTS

	Page
Introduction	7-3
Airspeeds For Normal Operation	7-3
NORMAL PROCEDURES	7-4
Preflight Inspection	7-4
Cabin	7-5
Left Wing	7-6
Left Wing Leading Edge	7-8
Left Wing Trailing Edge	7-8
Empennage	7-8
Right Wing Trailing Edge	7-9
Right Wing	7-9
Nose	7-11
Before Starting Engine	7-13
Starting Engine (With Battery)	7-13
Starting Engine (With External Power)	7-15
Before Takeoff	7-18
Takeoff	7-19
Normal Takeoff	7-19
Short Field Takeoff	7-19
Enroute Climb	7-20
Cruise	7-20
Descent	7-20
Before Landing	7-20
Landing	7-21
Normal Landing	7-21
Short Field Landing	7-21
Balked Landing	7-21
After Landing	7-22
Securing Airplane	7-22

(Continued Next Page)

TABLE OF CONTENTS (Continued)

	Page
AMPLIFIED NORMAL PROCEDURES	7-23
Preflight Inspection	7-23
Before Starting Engine	7-25
Starting Engine	7-25
Recommended Starter Duty Cycle	7-26
Leaning For Ground Operations	7-27
Taxiing	7-27
Before Takeoff	7-30
Warm Up	7-30
Magneto Check	7-30
Alternator Check	7-31
Electric Elevator Trim	7-31
Takeoff	7-31
Power Check	7-31
Wing Flap Settings	7-32
Crosswind Takeoff	7-33
Enroute Climb	7-33
Cruise	7-34
Leaning Without Exhaust Gas Temperature (EGT) Indicator ..	7-35
Leaning With Exhaust Gas Temperature (EGT) Indicator	7-36
Fuel Savings Procedures For Flight Training Operations	7-38
Stalls	7-39
Descent	7-39
Landing	7-40
Normal Landing	7-40
Short Field Landing	7-40
Crosswind Landing	7-41
Balked Landing	7-41
High Winds Operations	7-41
Cold Weather Operations	7-42
Starting	7-43
Winterization Kit	7-45/7-46
Hot Weather Operations	7-45/7-46

INTRODUCTION

Section 7 provides procedures and amplified instructions for normal operations using standard and simply operated optional equipment. Normal procedures associated with more complex optional equipment can be found in Section 10, Supplements.

AIRSPEEDS FOR NORMAL OPERATION

Unless otherwise noted, the following speeds are based on a maximum weight of 1320 pounds and may be used for any lesser weight.

TAKEOFF

Normal Climb	65 - 75 KIAS
Short Field Takeoff, Flaps 10°, Speed at 50 Feet	55 KIAS

ENROUTE CLIMB, FLAPS UP

Normal, Sea Level.	65 - 75 KIAS
Best Rate of Climb	62 KIAS
Best Angle of Climb.	57 KIAS

LANDING APPROACH

Normal Approach, Flaps UP	60 - 70 KIAS
Normal Approach, Flaps FULL	55 - 65 KIAS
Short Field Approach, Flaps FULL	50 KIAS

BALKED LANDING

Maximum Power, Flaps 25°	50 KIAS
------------------------------------	---------

MAXIMUM RECOMMENDED TURBULENT AIR PENETRATION SPEED

1320 POUNDS	89 KIAS
1200 POUNDS	85 KIAS
1100 POUNDS	80 KIAS

MAXIMUM DEMONSTRATED CROSSWIND VELOCITY

Takeoff or Landing.	12 KNOTS
-----------------------------	----------

MAXIMUM RECOMMENDED WIND VELOCITY

All Operations	22 KNOTS
--------------------------	----------

NORMAL PROCEDURES PREFLIGHT INSPECTION

B10717

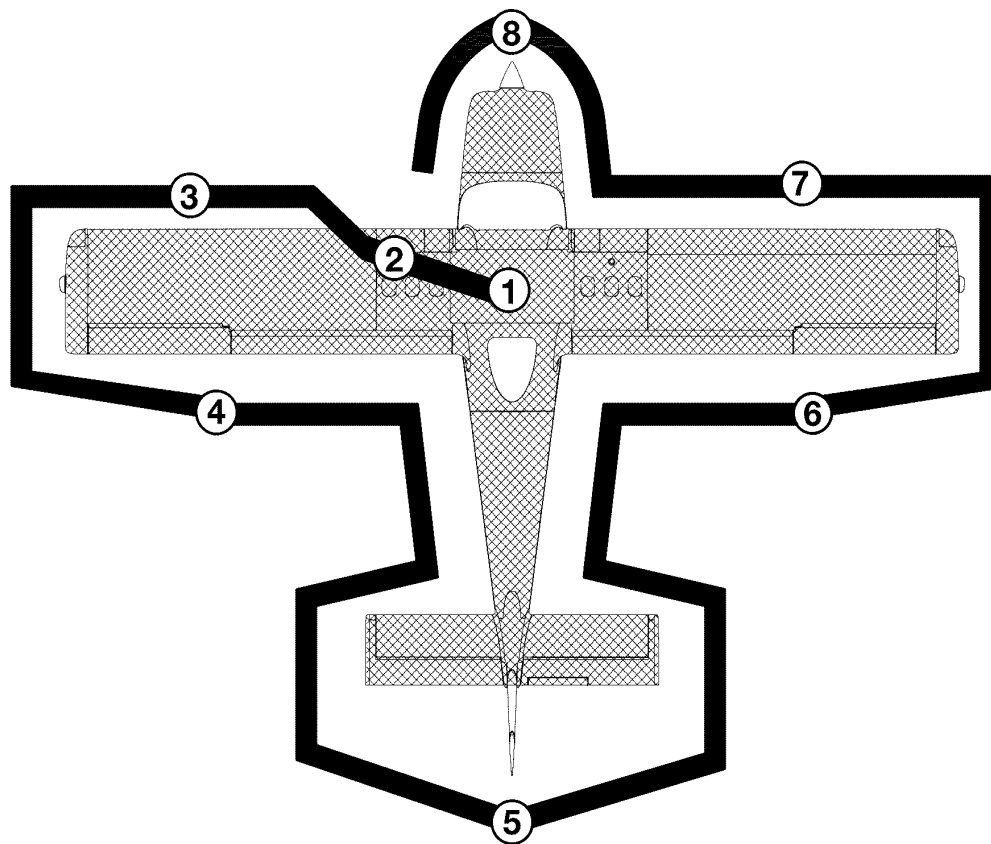

09101001

NOTE

Visually check airplane for general condition during walk-around inspection. Airplane should be parked in a normal ground attitude (refer to Figure 1-1) to make sure that fuel drain valves allow for accurate sampling. In cold weather, remove even small accumulations of frost, ice or snow from wing, tail and control surfaces. Also, make sure that control surfaces contain no internal accumulations of ice or debris. If a night flight is planned, check operation of all lights, and make sure a flashlight is available.

Figure 7-1

PREFLIGHT INSPECTION (Continued)

① CABIN

1. Pilot's Operating Handbook - AS REQUIRED
2. Garmin G300 Pilot's Guide - AS REQUIRED
3. Pilot's Checklist - AS REQUIRED
4. Parking Brake - SET
5. Control Stick Lock - REMOVE
6. Wing Flaps - UP
7. Fuel Quantity Indicators - CHECK (L and R)

WARNING

- **TAKEOFF IS PROHIBITED WITH LESS THAN $\frac{1}{4}$ TANK OF FUEL.**

GRND $\frac{\text{MIN}}{\text{T.O.}}$ MARKING ON FUEL INDICATOR

- **WHEN THE MASTER SWITCH IS ON, USING AN EXTERNAL POWER SOURCE, OR MANUALLY ROTATING THE PROPELLER, TREAT THE PROPELLER AS IF THE MAGNETOS SWITCH WERE ON. DO NOT STAND, NOR ALLOW ANYONE ELSE TO STAND, WITHIN THE ARC OF THE PROPELLER SINCE A LOOSE OR BROKEN WIRE, OR A COMPONENT MALFUNCTION, COULD CAUSE THE ENGINE TO START.**
8. MAGNETOS Switch - OFF
 9. MASTER Switch (ALT and BAT) - ON
 10. AVN MASTER Switch - ON
 11. Primary Flight Display (PFD) - CHECK (verify PFD is ON and software current)
 12. Multifunction Flight Display (MFD) - CHECK (if installed) (verify MFD is ON)
 13. PFD ADAHRS Test and MFD SELF TEST - COMPLETE (verify no red X's shown)

(Continued Next Page)

PREFLIGHT INSPECTION (Continued)

① **CABIN** (Continued)

14. LOW VOLTS Annunciator - CHECK (verify annunciator is shown)

NOTE

LOW VOLTS Annunciator will only be shown if battery voltage is less than 12.5 volts. Verify battery voltage on PFD/MFD ENG page.

15. Elevator Trim Control - T/O POSITION
16. Avionics Cooling Fan - CHECK (verify fan is operational)
17. Airplane Weight and Balance - CHECKED and ENTERED
18. AVN MASTER Switch - OFF
19. MASTER Switch (ALT and BAT) - OFF
20. Fire Extinguisher - CHECK (if installed) (verify gage pointer in green arc)

② **LEFT WING**

1. Cabin Door - CHECK (security and condition)
2. Main Wheel Tire - CHECK (proper inflation and general condition (weather checks, tread depth and wear, etc.))
3. Brake Line - CHECK (security and condition)
4. Wheel Fairings - CHECK (security and condition) (if installed)
5. Fresh Air Vent - CHECK (blockage)
6. Fuel Quantity - CHECK VISUALLY (for desired level)

WARNING

TAKEOFF IS PROHIBITED WITH LESS THAN ¼ TANK OF FUEL.

GRND $\frac{\text{MIN}}{\text{T.O.}}$ MARKING ON FUEL INDICATOR

7. Fuel Filler Cap - SECURE and VENT CLEAR

(Continued Next Page)

PREFLIGHT INSPECTION (Continued)

② **LEFT WING** (Continued)

8. Fuel Tank Sump Quick Drain Valves - DRAIN

Drain at least a cupful of fuel (using sampler cup) from each sump location to check for water, sediment, and proper fuel grade before each flight and after each refueling. If water is observed, take further samples until clear and then gently rock wings and lower tail to the ground to move any additional contaminants to the sampling points. Take repeated samples from **all** fuel drain points until **all** contamination has been removed. If contaminants are still present, refer to WARNING below and do not fly airplane.

NOTE

Collect all sampled fuel in a safe container. Dispose of the sampled fuel so that it does not cause a nuisance, hazard, or damage to the environment.

WARNING

IF, AFTER REPEATED SAMPLING, EVIDENCE OF CONTAMINATION STILL EXISTS, THE AIRPLANE SHOULD NOT BE FLOWN. TANKS SHOULD BE DRAINED AND SYSTEM PURGED BY QUALIFIED MAINTENANCE PERSONNEL. ALL EVIDENCE OF CONTAMINATION MUST BE REMOVED BEFORE FURTHER FLIGHT.

(Continued Next Page)

PREFLIGHT INSPECTION (Continued)

③ LEFT WING Leading Edge

1. Fuel Tank Vent Opening - CHECK (blockage)
2. Wing Tiedown - DISCONNECT (check security and condition)
3. Pitot Tube Cover - REMOVE (check for pitot blockage)
4. Landing Light - CHECK (condition, operation and cleanliness of cover)
5. Strobe/Nav Light - CHECK (condition, operation and cleanliness of cover)

④ LEFT WING Trailing Edge

1. Aileron - CHECK (freedom of movement and security)

NOTE

Check for proper aileron movement by pushing the aileron up from the neutral (or faired with the flaps in the Flaps UP position) and returning the aileron back to the neutral or faired position. Pushing down on the aileron may create an over-centered condition requiring re-centering of the cockpit control stick.

2. Flap - DEFLECT and CHECK (flap/aileron cables, up-spring tension and general condition)
3. Com Antenna and OAT Temp Probe - CHECK (security of attachment and general condition)

⑤ EMPENNAGE

1. Rudder Gust Lock (if installed) - REMOVE
2. Control Surfaces - CHECK (freedom of movement and security)
3. Elevator Trim Tab - CHECK (security) (verify tab is faired with elevator and trim indicator in T/O position)
4. Tail Tiedown - DISCONNECT

(Continued Next Page)

PREFLIGHT INSPECTION (Continued)

⑥ RIGHT WING Trailing Edge

1. ELT and GPS Antennas - CHECK (security of attachment and general condition)
2. Flap - DEFLECT and CHECK (flap/aileron cables, up-spring tension and general condition)
3. Aileron - CHECK (freedom of movement and security)

NOTE

Check for proper aileron movement by pushing the aileron up from the neutral (or faired with the flaps in the Flaps UP position and returning the aileron back to the neutral or faired position. Pushing down on the aileron may create an over-centered condition requiring re-centering of the cockpit control stick.

⑦ RIGHT WING

1. Strobe/Nav Light - CHECK (condition, operation and cleanliness of cover)
2. Wing Tiedown - DISCONNECT (check security and condition)
3. Stall Warning Opening - CHECK (blockage)

NOTE

To check the system, place a clean handkerchief over the vent opening and apply suction; a sound from the warning horn will confirm system operation.

4. Fuel Quantity - CHECK VISUALLY (for desired level)

WARNING

TAKEOFF IS PROHIBITED WITH LESS THAN ¼ TANK OF FUEL.

GRND $\frac{\text{MIN}}{\text{T.O.}}$ MARKING ON FUEL INDICATOR

(Continued Next Page)

PREFLIGHT INSPECTION (Continued)

⑦ **RIGHT WING** (Continued)

5. Fuel Filler Cap - SECURE and VENT CLEAR
6. Main Wheel Tire - CHECK (proper inflation and general condition (weather checks, tread depth and wear, etc.))
7. Brake Line - CHECK (security and condition)
8. Wheel Fairings - CHECK (security and condition) (if installed)
9. Fuel Tank Sump Quick Drain Valves - DRAIN

Drain at least a cupful of fuel (using sampler cup) from each sump location to check for water, sediment, and proper fuel grade before each flight and after each refueling. If water is observed, take further samples until clear and then gently rock wings and lower tail to the ground to move any additional contaminants to the sampling points. Take repeated samples from **all** fuel drain points until **all** contamination has been removed. If contaminants are still present, refer to WARNING below and do not fly airplane.

NOTE

Collect all sampled fuel in a safe container. Dispose of the sampled fuel so that it does not cause a nuisance, hazard or damage to the environment.

WARNING

IF, AFTER REPEATED SAMPLING, EVIDENCE OF CONTAMINATION STILL EXISTS, THE AIRPLANE SHOULD NOT BE FLOWN. TANKS SHOULD BE DRAINED AND SYSTEM PURGED BY QUALIFIED MAINTENANCE PERSONNEL. ALL EVIDENCE OF CONTAMINATION MUST BE REMOVED BEFORE FURTHER FLIGHT.

10. Cabin Door - CHECK (security and condition)
11. Fresh Air Vent - CHECK (blockage)

PREFLIGHT INSPECTION (Continued)

⑧ NOSE

1. Engine Cooling Air Inlets - CHECK (clear of obstructions)
2. Propeller and Spinner - CHECK (for nicks and security)
3. Air Filter - CHECK (for condition and blockage by dust or other foreign matter)
4. Nosewheel Strut and Tire - CHECK (strut and general condition of tire (weather checks, tread depth and wear, etc.))
5. Nosewheel Fairing - CHECK (security and condition) (if installed)
6. Engine Exhaust Outlet - CHECK (security and condition)
7. Engine Oil Dipstick/Filler Cap:
 - a. Oil level - CHECK
 - b. Dipstick/filler cap - SECURE (lever horizontal and facing aft)

NOTE

Do not operate with less than 3.5 quarts. Fill to 5 quarts for extended flight.

8. Fuel Strainer Quick Drain Valve - DRAIN (bottom left side of engine cowling)
Drain at least a cupful of fuel (using sampler cup) from valve to check for water, sediment, and proper fuel grade before each flight and after each refueling. If water is observed, take further samples until clear and then gently rock wings and lower tail to the ground to move any additional contaminants to the sampling points. Take repeated samples from **all** fuel drain points, including the fuel strainer and fuel sump valve, until **all** contamination has been removed. If contaminants are still present, refer to WARNING below and do not fly the airplane.

NOTE

Collect all sampled fuel in a safe container. Dispose of the sampled fuel so that it does not cause a nuisance, hazard, or damage to the environment.

(Continued Next Page)

PREFLIGHT INSPECTION (Continued)

⑧ NOSE (Continued)

WARNING

IF, AFTER REPEATED SAMPLING, EVIDENCE OF CONTAMINATION STILL EXISTS, THE AIRPLANE SHOULD NOT BE FLOWN. TANKS SHOULD BE DRAINED AND SYSTEM PURGED BY QUALIFIED MAINTENANCE PERSONNEL. ALL EVIDENCE OF CONTAMINATION MUST BE REMOVED BEFORE FURTHER FLIGHT.

9. Fuselage Fuel Sump Quick Drain Valve (bottom center rear of engine cowling) - DRAIN
Drain at least a cupful of fuel (using sampler cup) from valve to check for water, sediment, and proper fuel grade before each flight and after each refueling. If water is observed, take further samples until clear and then gently rock wings and lower tail to the ground to move any additional contaminants to the sampling points. Take repeated samples from **all** fuel drain points, including the fuel strainer and fuel sump valve, until **all** contamination has been removed. If contaminants are still present, refer to WARNING below and do not fly the airplane.

NOTE

Collect all sampled fuel in a safe container. Dispose of the sampled fuel so that it does not cause a nuisance, hazard, or damage to the environment.

WARNING

IF, AFTER REPEATED SAMPLING, EVIDENCE OF CONTAMINATION STILL EXISTS, THE AIRPLANE SHOULD NOT BE FLOWN. TANKS SHOULD BE DRAINED AND SYSTEM PURGED BY QUALIFIED MAINTENANCE PERSONNEL. ALL EVIDENCE OF CONTAMINATION MUST BE REMOVED BEFORE FURTHER FLIGHT.

10. Static Source Opening (left side of fuselage) - CHECK (verify opening is clear)

BEFORE STARTING ENGINE

1. Preflight Inspection - COMPLETE
2. Passenger Briefing - COMPLETE
3. Rudder Pedals - ADJUST
4. Seat Belts - ADJUST and SECURE
5. Cabin Doors - AS DESIRED
6. Brakes - TEST and SET
7. Circuit Breakers - CHECK IN
8. Electrical Equipment - OFF
9. AVN Master Switch - OFF

CAUTION

THE AVIONICS MASTER SWITCH MUST BE OFF DURING ENGINE START TO PREVENT POSSIBLE DAMAGE TO AVIONICS.

10. FUEL SHUTOFF Valve - ON (push full in)

STARTING ENGINE (With Battery)

IF FUEL PRIMER CONTROL INSTALLED

1. Fuel PRIMER Control - AS REQUIRED
 - a. Engine COLD - PUMP (1 to 3 strokes)
 - b. Engine WARM - NONE

IF FUEL PRIMER CONTROL NOT INSTALLED

1. THROTTLE Control - AS REQUIRED
 - a. Engine COLD - PUMP (3 to 6 strokes)
 - b. Engine WARM - PUMP ONCE (push full in and pull full out)

STARTING ENGINE (With Battery) (Continued)

2. CARB HEAT Control Knob - OFF (push full in)
3. THROTTLE Control - AS REQUIRED
 - a. Engine COLD - OPEN 1/4 INCH
 - b. Engine WARM - CLOSED
4. MIXTURE Control - FULL RICH (push full in)

(Continued Next Page)

STARTING ENGINE (With Battery) (Continued)

5. AVN MASTER Switch - OFF
6. MASTER Switch (ALT and BAT) - ON
7. Engine Indicating System - CHECK PARAMETERS (verify no red X's through indicators)
8. VOLTS - CHECK EIS ENGINE PAGE

NOTE

A red LOW VOLTS annunciator will come on when battery voltage is less than 12.5 volts. As battery voltage decreases, the Garmin G300 display will become less bright and eventually unreadable. If the starter fails to crank the engine or the G300 display becomes unreadable, service battery or apply external power.

9. AMPS - CHECK (verify discharge shown (negative))
10. Propeller Area - CLEAR (verify that all people and equipment are at a safe distance from the propeller)
11. STROBE Light Switch - ON
12. MAGNETOS Switch - START (release when engine starts)

NOTE

If the engine is primed too much (flooded), place the mixture control in the IDLE CUTOFF position, open the throttle control 1/2 to full, and engage the starter motor (START). When the engine starts, advance the mixture control to the FULL RICH position and promptly retard the throttle control.

13. Oil Pressure - CHECK (verify that oil pressure increases above 10 PSI into the YELLOW BAND range in 30 seconds)
14. AMPS - CHECK (verify charge shown (positive))
15. NAV Light Switch - ON (as required)
16. STROBE Light Switch - OFF
17. AVN MASTER Switch - ON
18. MIXTURE Control - LEAN (as required)

STARTING ENGINE (With External Power) (if installed)

IF FUEL PRIMER CONTROL INSTALLED

1. Fuel PRIMER Control - AS REQUIRED
 - a. Engine COLD - PUMP (1 to 3 strokes)
 - b. Engine WARM - NONE

IF FUEL PRIMER CONTROL NOT INSTALLED

1. THROTTLE Control - AS REQUIRED
 - a. Engine COLD - PUMP (3 to 6 strokes)
 - b. Engine WARM - PUMP ONCE (push full in and pull full out)

STARTING ENGINE (With External Power) (Continued)

2. CARB HEAT Control Knob - OFF (push full in)
3. THROTTLE Control - AS REQUIRED
 - a. Engine COLD - OPEN 1/4 INCH
 - b. Engine WARM - CLOSED
4. MIXTURE Control - FULL RICH (push full in)
5. AVN MASTER Switch - OFF
6. MASTER Switch (ALT and BAT) - ON
7. Engine Indicating System - CHECK PARAMETERS (verify no red X's through indicators)
8. VOLTS - CHECK EIS ENGINE PAGE

NOTE

A red LOW VOLTS annunciator will come on when battery voltage is less than 12.5 volts. As battery voltage decreases, the Garmin G300 display will become less bright and eventually unreadable. If the G300 display becomes unreadable, connect external power per the following procedure. The battery may require servicing.

9. AMPS - CHECK (verify discharge shown (negative))
10. MASTER Switch (ALT and BAT) - OFF
11. EXTERNAL POWER - CONNECT (to external power receptacle)
12. MASTER Switch (ALT and BAT) - ON

(Continued Next Page)

STARTING ENGINE (With External Power) (if installed) (Continued)

13. Engine Indicating System - CHECK PARAMETERS (verify no red X's through indicators)
14. VOLTS - CHECK EIS ENGINE PAGE (verify 12.5 to 15.0 volts indication and LOW VOLTS annunciation is not shown)
15. AMPS - CHECK (verify charge shown (positive))
16. Propeller Area - CLEAR (verify that all people and equipment are at a safe distance from the propeller)
17. STROBE Lights Switch - ON
18. MAGNETOS Switch - START (release when engine starts)

NOTE

If the engine is primed too much (flooded), place the mixture control in the IDLE CUTOFF position, open the throttle control 1/2 to full, and engage the starter motor (START). When the engine starts, advance the mixture control to the FULL RICH position and promptly retard the throttle control.

19. Oil Pressure - CHECK (verify that oil pressure increases above 10 PSI into the YELLOW BAND range in 30 seconds)
20. Power - REDUCE TO IDLE
21. EXTERNAL POWER - DISCONNECT FROM GROUND POWER (latch external power receptacle door)
22. Power - INCREASE (to approximately 1500 RPM for several minutes to charge battery)
23. AMPS - CHECK (verify charge shown (positive))
24. VOLTS - CHECK EIS ENGINE PAGE (verify 12.5 VOLTS minimum shown)
25. LOW VOLTS Annunciator - CHECK (verify annunciator is not shown)

(Continued Next Page)

STARTING ENGINE (With External Power) (if installed)
(Continued)

26. Internal Power - CHECK
 - a. MASTER Switch (ALT) - OFF
 - b. LDG Light Switch - ON
 - c. NAV Light Switch - ON
 - d. THROTTLE Control - REDUCE TO IDLE
 - e. MASTER Switch (ALT) - ON
 - f. THROTTLE Control - INCREASE (to approximately 1500 RPM)
 - g. AMPS - CHECK (verify charge shown (positive))

WARNING

IF AMMETER DOES NOT SHOW POSITIVE CHARGE (+ AMPS), REMOVE THE BATTERY FROM THE AIRPLANE AND SERVICE OR REPLACE THE BATTERY BEFORE FLIGHT.

27. LDG Light Switch - OFF (as required)
28. STROBE Light Switch - OFF
29. AVN MASTER Switch - ON
30. MIXTURE Control - LEAN (as required)

BEFORE TAKEOFF

1. Parking Brake - SET
 - a. Brakes - Apply
 - b. PARKING BRAKE Control Knob - ON (pull full out)
2. Seats and Seat Belts - CHECK SECURE
3. Cabin Doors - CLOSED and LOCKED
4. Flight Controls - FREE and CORRECT
5. Flight Instruments (PFD) - CHECK (verify no red X's through indicators)
6. Engine Indicating System - CHECK PARAMETERS (verify no red X's through indicators)
7. Altimeter - SET
8. Fuel Quantity Indicators - CHECK (verify level is correct)

WARNING

TAKEOFF IS PROHIBITED WITH LESS THAN ¼ TANK OF FUEL.

GRND $\frac{\text{MIN}}{\text{T.O.}}$ MARKING ON FUEL INDICATOR

9. PRIMER Control Knob (if installed) - IN and LOCKED
10. MIXTURE Control - RICH
11. Autopilot - ENGAGE (if installed) (push AP button on autopilot control panel)
 - a. Flight Controls - CHECK (verify autopilot can be overpowered in both pitch and roll axes)
 - b. A/P DISC Button - PRESS (if installed) (verify autopilot disengages and aural alert is heard)
12. Elevator Trim Control Switch - SET FOR T/O
13. THROTTLE Control - 1700 RPM (once oil temperature is above 75°F and oil pressure in green band range)
 - a. MAGNETOS Switch - CHECK (RPM drop should not exceed 150 RPM on either magneto or 50 RPM differential between magnetos)
 - b. Engine Indicators - CHECK
 - c. CARB HEAT Control Knob - ON
 - (1) Engine RPM - CHECK (verify RPM decreases)
 - (2) CARB °F - CHECK (verify temp increases)
 - d. AMPS and VOLTS - CHECK

(Continued Next Page)

BEFORE TAKEOFF (Continued)

14. Annunciators - CHECK (verify no annunciators are shown)
15. THROTTLE Control - CHECK IDLE (900 RPM or LESS)
16. THROTTLE Control Friction Lock - ADJUST
17. COM Frequency - SET
18. GPS Flight Plan - AS DESIRED
19. XPDR - SET
20. Wing Flaps - UP - 10° (10° recommended)
21. NAV Light Switch - ON
22. STROBE Light Switch - ON
23. PARKING BRAKE Control Knob - OFF (push full in)

TAKEOFF

NORMAL TAKEOFF

1. Wing Flaps - UP - 10° (10° recommended)
2. CARB HEAT Control Knob - OFF (push full in)
3. THROTTLE Control - FULL (push full in)
4. MIXTURE Control - RICH (above 5000 feet pressure altitude, lean for maximum RPM)
5. Directional Control - MAINTAIN (use differential braking until rudder control becomes effective)
6. Elevator Control - LIFT NOSEWHEEL AT 50 KIAS
7. Climb Airspeed - 65 - 75 KIAS
8. Wing Flaps - RETRACT (at safe altitude)

SHORT FIELD TAKEOFF

1. Wing Flaps - 10°
2. CARB HEAT Control Knob - OFF (push full in)
3. Brakes - APPLY
4. THROTTLE Control - FULL (push full in)
5. MIXTURE Control - RICH (above 5000 feet pressure altitude, lean for maximum RPM)
6. Brakes - RELEASE
7. Elevator Control - SLIGHTLY TAIL LOW
8. Directional Control - MAINTAIN (use differential braking until rudder control becomes effective)
9. Climb Airspeed - 55 KIAS (until all obstacles are cleared)
10. Wing Flaps - RETRACT SLOWLY (when airspeed is more than 60 KIAS)

ENROUTE CLIMB

1. Airspeed - 65 - 75 KIAS
2. THROTTLE Control - FULL (push full in)
3. MIXTURE Control - RICH (above 5000 feet pressure altitude, lean for maximum RPM)

NOTE

For maximum performance climb speeds, refer to Section 5, Figure 5-5, Maximum Rate of Climb at 1320 Pounds.

CRUISE

1. Power - 2400 - 2750 RPM (75% recommended)
2. Elevator Trim Control Switch - ADJUST
3. MIXTURE Control - LEAN (for best power setting)

DESCENT

1. Power - AS DESIRED (2750 RPM maximum)
2. MIXTURE Control - ADJUST (if necessary to make engine run smoothly)
3. Altimeter - SET
4. Wing Flaps - AS DESIRED (UP - 10° below 100 KIAS)
(10° - 25° below 85 KIAS)
(25° - FULL below 70 KIAS)
5. CARB HEAT Control Knob - ON (as required)

BEFORE LANDING

1. Seats and Seat Belts - SECURED and LOCKED
2. MIXTURE Control - RICH (push full in) (below 5000 feet pressure altitude)
3. CARB HEAT Control Knob - ON (pull full out) (apply full heat before reducing power)
4. LDG Light Switch - ON
5. Autopilot - OFF (if installed)

LANDING

NORMAL LANDING

1. Airspeed - 60 - 70 KIAS (Flaps UP)
2. Wing Flaps - AS DESIRED (UP - 10° below 100 KIAS)
(10° - 25° below 85 KIAS)
(25° - FULL below 70 KIAS)
3. Airspeed - 55 - 65 KIAS (Flaps FULL)
4. Elevator Trim Control Switch - ADJUST
5. Touchdown - MAIN WHEELS FIRST
6. Landing Roll - LOWER NOSEWHEEL GENTLY
7. Braking - MINIMUM REQUIRED
8. Directional Control - MAINTAIN (with rudder and differential braking)

SHORT FIELD LANDING

1. Airspeed - 60 - 70 KIAS (Flaps UP)
2. Wing Flaps - FULL
3. Airspeed - 50 KIAS (until flare)
4. Elevator Trim Control - ADJUST
5. Power - REDUCE TO IDLE (as obstacle is cleared)
6. Touchdown - MAIN WHEELS FIRST
7. Brakes - APPLY HEAVILY (while maintaining directional control)
8. Wing Flaps - UP

BALKED LANDING

1. THROTTLE Control - FULL (push full in)
2. CARB HEAT Control Knob - OFF (push full in)
3. Wing Flaps - RETRACT to 25°
4. Climb Speed - 50 KIAS (until obstacle is cleared)
5. Climb Speed - 60 KIAS (after obstacle is cleared)
6. Wing Flaps - 10°, then UP (after reaching a safe altitude and 60 KIAS)

AFTER LANDING

1. CARB HEAT Control Knob - OFF (push full in)
2. Wing Flaps - UP
3. STROBE Light Switch - OFF
4. Transponder - STBY

SECURING AIRPLANE

1. Parking Brake - SET
 - a. Brakes - APPLY
 - b. PARKING BRAKE Control Knob - ON (pull full out)
2. THROTTLE Control - IDLE (pull full out)
3. Electrical Equipment - OFF
4. AVN MASTER Switch - OFF
5. MIXTURE Control - IDLE CUTOFF (pull full out)
6. MAGNETOS Switch - OFF
7. MASTER Switch (ALT and BAT) - OFF
8. Control Lock - INSTALL

AMPLIFIED NORMAL PROCEDURES

PREFLIGHT INSPECTION

The preflight inspection, described in Figure 7-1 and adjacent checklist, is required prior to each flight. If the airplane has been in extended storage, has had recent major maintenance, or has been operated from rough runways, a more extensive exterior inspection is recommended.

Before every flight, check the condition of main and nose landing gear tires. Keep tires inflated to the pressure specified in Section 8, Airplane Handling, Service And Maintenance. Examine tire sidewalls for patterns of shallow cracks called weather checks. These cracks are evidence of tire deterioration caused by age, improper storage, or prolonged exposure to weather. Check the tread of the tire for depth, wear, and cuts. Replace the tire if fibers are visible.

After major maintenance has been performed, the flight and trim tab controls should be double checked for free and correct movement and security. The security of all inspection plates on the airplane should be checked following periodic inspections. If the airplane has been waxed or polished, check the external static pressure source hole for stoppage.

If the airplane has been kept in a crowded hangar, it should be checked for dents and scratches on wings, fuselage, and tail surfaces, damage to navigation/strobe light assemblies, wing tip fairings and avionics antennas. Check for damage to the nosewheel travel stops and wheel fairings (if installed), resulting from exceeding nosewheel turning limits while towing.

Outside storage for long periods may result in dust and dirt accumulation on the induction air filter, obstructions in airspeed system lines, water contaminants in fuel tanks, and insect/bird/rodent nests in any opening. If any water is detected in the fuel system, the fuel tank sump quick drain valves, fuel sump quick drain valve, and fuselage sump quick drain valve should all be thoroughly drained again. The wings should then be gently rocked and the tail lowered to the ground to move any further contaminants to the sampling points. Repeated samples should then be taken at **all** quick drain points until **all** contamination has been removed.

(Continued Next Page)

PREFLIGHT INSPECTION (Continued)

NOTE

Collect all sampled fuel in a safe container. Dispose of the sampled fuel so that it does not cause a nuisance, hazard, or damage to the environment.

WARNING

IF, AFTER REPEATED SAMPLING, EVIDENCE OF CONTAMINATION STILL EXISTS, THE AIRPLANE SHOULD NOT BE FLOWN. TANKS SHOULD BE DRAINED AND SYSTEM PURGED BY QUALIFIED MAINTENANCE PERSONNEL. ALL EVIDENCE OF CONTAMINATION MUST BE REMOVED BEFORE FURTHER FLIGHT.

When parked on the ramp, care should be exercised to make sure wings are level or the left wing slightly higher to prevent fuel from dripping from the fuel vent when fuel tanks are full. To prevent loss of fuel in flight, make sure the fuel tank filler caps are tightly sealed after any fuel system check or servicing. Fuel system vents should also be inspected for obstructions, ice or water, especially after exposure to cold, wet weather.

If the airplane has been stored outside in windy or gusty areas, or tied down adjacent to taxiing airplanes, special attention should be paid to control surface stops, hinges, and brackets to detect the presence of potential wind damage.

Airplanes that are operated from rough fields, especially at high altitudes, are subjected to abnormal landing gear abuse. Frequently check all components of the landing gear, strut, tires, and brakes. If the airplane has been operated from muddy fields or in snow or slush, check the main and nose gear wheel fairings for obstructions and cleanliness.

Operation from a gravel or cinder field will require extra attention to propeller tips and abrasion on leading edges of the horizontal tail. Stone damage to the propeller can seriously reduce the fatigue life of the blades.

BEFORE STARTING ENGINE

Rudder pedals should be adjusted fore and aft as needed to ensure the pilot has full brake deflection with the rudder fully deflected. A small percentage of pilots may require additional cushions to correctly position themselves for visibility and control.

Ideally, the pilot should be positioned so that the outboard elbow naturally rests on the door armrest and the control stick falls within the hand of that arm. Correct positioning allows for relaxed flying using wrist movements and assists the new pilot to adjusting to the Skycatcher flight controls.

STARTING ENGINE

Engine starting can differ depending on the temperature of the engine and surrounding ambient air which affects the amount of fuel priming required. Standard priming is done using the throttle control. Pumping the throttle, by rapidly advancing the throttle control fully in and out, works an accelerator pump in the engine carburetor for priming. In this way, the throttle may be pumped or given some number of "strokes" to provide the required prime. An optional plunger style primer may be used to provide fuel prime (if installed).

If the engine is already warm, pump the throttle once then leave the throttle closed to start. No additional priming should be required. A cold engine with moderately warm (room temperature) ambient air will require 1 or 2 strokes of the throttle (or primer). A cold engine with cold ambient air (temperatures above freezing) will require up to 3 or 4 strokes of throttle (or primer). A cold engine should have the throttle open approximately $\frac{1}{4}$ inch for start.

In extremely cold temperatures, it may be necessary to continue priming while cranking the engine. If the engine is under primed, most likely in cold weather with a cold engine, it will not fire at all, and additional priming will be necessary. As soon as the cylinders begin to fire, open the throttle slightly to keep it running.

(Continued Next Page)

STARTING ENGINE (Continued)

Weak intermittent firing followed by puffs of black smoke from the exhaust stack indicates over priming or flooding. Excess fuel can be cleared from the combustion chambers by the following procedure: set parking brake and hold brakes, set the mixture control full lean (idle cutoff) and the place throttle control to full open; then crank the engine through several revolutions with the starter. Be prepared to immediately reduce throttle control to idle once engine starts. Repeat the starting procedure without any additional priming.

After starting, if the oil pressure gage does not begin to show pressure within 30 seconds in the summertime and about twice that long in very cold weather, stop the engine and investigate. Lack of oil pressure can cause serious engine damage. After starting, avoid the use of carburetor heat unless icing conditions prevail.

NOTE

Additional details concerning cold weather starting and operation may be found under COLD WEATHER OPERATION paragraphs in this section.

After the completion of normal engine starting procedures, it is a good practice to verify that the engine starter has disengaged. If the starter contactor were to stick closed, causing the starter to remain engaged, an excessively high charge indication (full scale at 1000 RPM) would be evident on the ammeter. In this event, immediately shut down engine and have electrical system inspected by qualified maintenance personnel prior to next flight.

RECOMMENDED STARTER DUTY CYCLE

Operate the starter motor for 10 seconds followed by a 20 second cool down period. This cycle can be repeated five additional times, followed by a thirty minute cool down period before resuming cranking. After cool down, operate the starter motor again, six cycles of 10 seconds followed by 20 seconds of cool down. If the engine still does not start, try to find the cause.

LEANING FOR GROUND OPERATIONS

For all ground operations, after starting the engine and when the engine is running smoothly:

1. THROTTLE Control - 1200 RPM
2. Mixture Control - ADJUST (lean for maximum RPM)
3. THROTTLE Control - ADJUST for ground operation (800 to 1000 RPM recommended)

NOTE

If ground operation will be required after the BEFORE TAKEOFF checklist is completed, lean the mixture again (as described above) until ready for the TAKEOFF checklist.

TAXIING

CAUTION

DUE TO LOWER WEIGHTS AND SLOWER STALL SPEEDS THAN LARGER AIRPLANES, PROPER TAXI TECHNIQUES SHOULD BE USED IN WINDY CONDITIONS. OPERATIONS IN WIND CONDITIONS ABOVE 22 KNOTS ARE NOT RECOMMENDED.

When taxiing, the combination of differential braking and free-castoring nose wheel provide excellent ground maneuvering in tight spaces as well as control during normal taxiing. Differential brake application should be done by firm, short taps of the brake pedal so as to nudge the airplane in the desired direction. Excess speed and "riding a brake" should be avoided since this can cause brake heating, brake fade, or loss of braking effectiveness resulting in loss of control or stopping ability.

It is important that taxi speed be held to that of a brisk walk and all flight controls be utilized up to their maximum deflection (refer to Figure 7-2, Taxiing Diagram) to aid in maintaining directional control. This is particularly important in windy conditions.

(Continued Next Page)

TAXIING (Continued)

NOTE

Strong or gusty tail winds can over power the wing flap return springs causing the flaps to randomly blow down while taxiing. Selecting flaps to FULL when taxiing with a tailwind can prevent the blow down. Use caution to prevent a build-up of taxi speed due to blowing by strong tailwinds. Flaps should be retracted when turning away from the tailwind condition and the BEFORE TAKEOFF Checklist should be used to insure flaps are properly reset before takeoff.

The CARB HEAT control knob should be pushed full in to the OFF position during all ground operations unless carb heat is absolutely necessary to correct engine roughness. When the CARB HEAT control knob is pulled out to the ON position, air entering the engine is not filtered. However, if needed, use FULL CARB HEAT until engine roughness clears. Monitoring the CARB °F Indicator will assist in amount of carb heat required to keep the carburetor temperature out of the yellow caution range and prevent engine roughness.

Taxiing over loose gravel or cinders should be done at the lowest engine RPM possible to avoid abrasion and stone damage to the propeller tips.

(Continued Next Page)

TAXIING (Continued)

TAXIING DIAGRAM

B10718

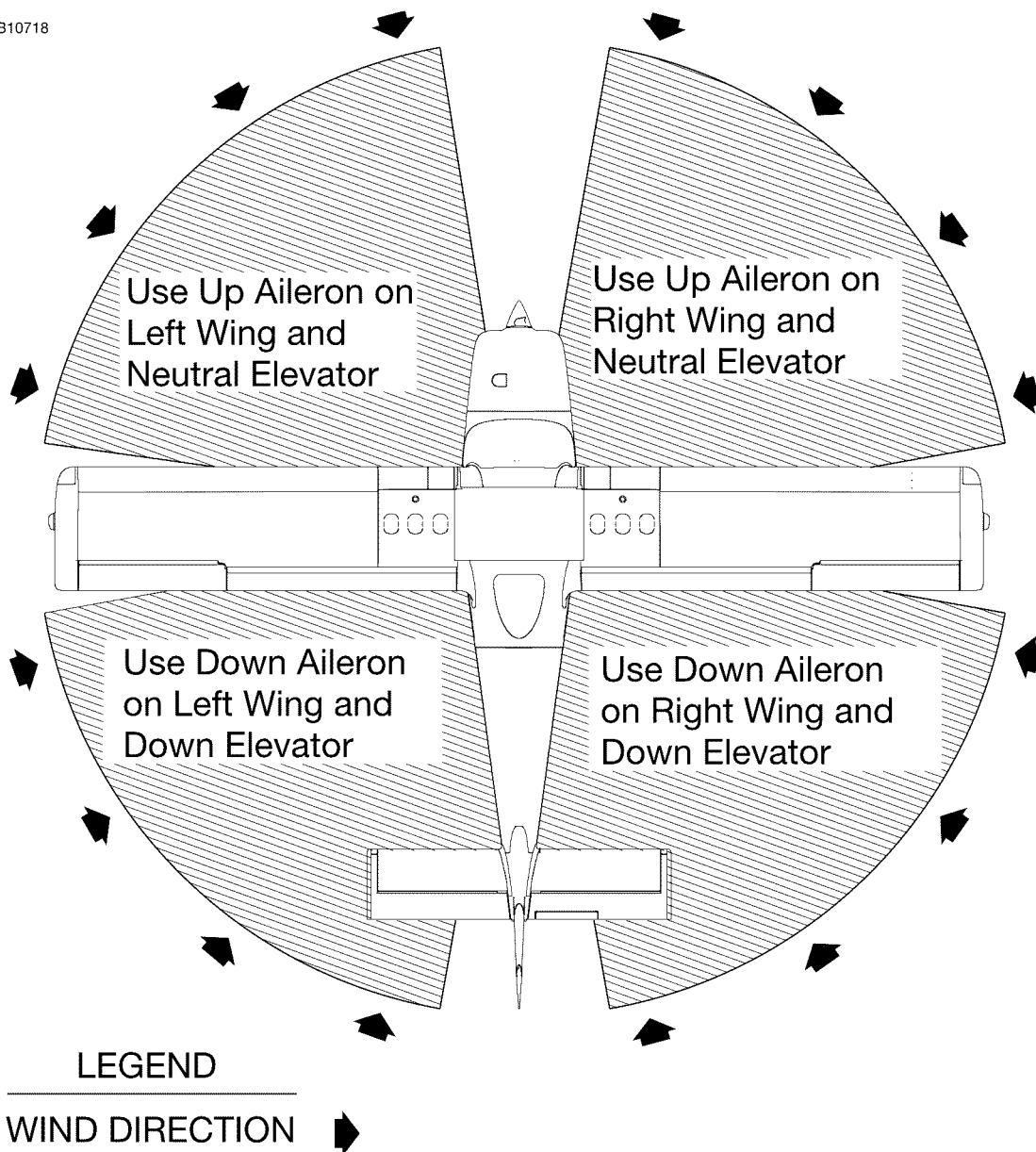

0910T1002

NOTE

Strong quartering tail winds require caution. Avoid sudden bursts of the throttle and sharp braking when the airplane is in this attitude. Use differential braking and rudder to maintain direction.

Figure 7-2

BEFORE TAKEOFF

WARM UP

If the engine idles with the throttle against the idle stop, approximately 700 to 800 RPM and accelerates smoothly, the engine is warm enough for takeoff. Since the engine is closely cowled for efficient in-flight engine cooling, the airplane should be pointed into the wind to avoid overheating during prolonged engine operation on the ground. Refer to Leaning For Ground Operations procedures to prevent spark plug fouling that can occur from long periods of idling and prolonged ground operations.

MAGNETO CHECK

CAUTION

MAKE SURE ENGINE OIL TEMPERATURE IS ABOVE 75°F AND OIL PRESSURE IS WITHIN THE GREEN BAND RANGE PRIOR TO PREFORMING A MAGNETO CHECK.

The magneto check must be made at 1700 RPM. Turn the MAGNETOS switch from the BOTH position to the R position. Note the new RPM, then turn the MAGNETOS switch back to the BOTH position to clear the spark plugs. Turn the MAGNETOS switch to the L position, note the new RPM, then turn the switch back to the BOTH position. RPM decrease should not be more than 150 RPM on either magneto or be greater than 50 RPM differential between magnetos. If there is a doubt concerning operation of the ignition system, RPM checks at higher engine speeds will usually confirm whether a deficiency exists.

No RPM drop may indicate a faulty ground to one magneto or magneto timing set in advance of the angle specified.

(Continued Next Page)

BEFORE TAKEOFF (Continued)

ALTERNATOR CHECK

The alternator should be checked for proper operation before every flight. Electrical power is essential for all flight instrumentation, navigation, and radio operation. Check the electrical system during the **MAGNETO** check (1700 RPM) by setting all electrical equipment required for the flight to the ON position. When the alternator is operating properly, the ammeters will show zero or positive current (+ amps), the voltmeter will show 13 to 15 volts, and the LOW VOLTS annunciator will not be shown on the PFD. Reduce the electrical load before reducing engine speed so the battery will not discharge while the engine is at idle.

ELECTRIC ELEVATOR TRIM

Make sure the elevator trim tab is in the takeoff position when the trim pointer is aligned with the T/O index mark on the EIS TRIM indicator. Adjust the trim during flight as necessary to make control wheel forces more neutral.

TAKEOFF

POWER CHECK

It is important to check full throttle engine operation early in the takeoff roll. Any sign of rough engine operation or sluggish engine acceleration is good cause for discontinuing the takeoff. If this occurs, you are justified in making a thorough full throttle static run-up before another takeoff is attempted. The engine should run smoothly and turn approximately 2375 - 2475 RPM with carburetor heat off and the mixture leaned to provide maximum RPM.

NOTE

Carburetor heat should not be used during takeoff unless it is absolutely necessary to obtain smooth engine acceleration.

(Continued Next Page)

TAKEOFF (Continued)

POWER CHECK (Continued)

Full throttle run-ups over loose gravel are especially harmful to propeller tips. When takeoffs must be made over a gravel surface, advance the throttle slowly. This allows the airplane to start rolling before high RPM is developed, and the gravel will be blown behind the propeller rather than pulled into it.

- Prior to takeoff from fields above 5000 feet pressure altitude, the mixture should be leaned to give maximum RPM at full throttle, with the airplane not moving.

After full throttle is applied, adjust the throttle friction lock clockwise to prevent the throttle from moving back from a maximum power position. Similar friction lock adjustments should be made as required in other flight conditions to hold the throttle setting.

WING FLAP SETTINGS

Normal takeoffs use wing flaps UP - 10°. Using 10° wing flaps reduces the ground roll to lift off while keeping the total distance over an obstacle by equivalent to the flaps UP distances. **Flap deflections greater than 10° are not approved for takeoff.** If 10° wing flaps are used for takeoff, the flaps should stay at 10° until all obstacles are cleared and a safe flap retraction speed of 60 KIAS is reached. For a short field, 10° wing flaps and an obstacle clearance speed of 55 KIAS should be used.

Soft or rough field takeoffs are performed with 10° flaps by lifting the airplane off the ground as soon as practical in a slightly tail low attitude. If no obstacles are ahead, the airplane should be leveled off immediately to accelerate to a higher climb speed. When departing a soft field with an aft C.G. loading, the elevator trim control should be adjusted towards the nose down direction to give comfortable control wheel forces during the initial climb.

TAKEOFF (Continued)

CROSSWIND TAKEOFF

Takeoffs under strong crosswind conditions normally are performed with the minimum flap setting necessary for the field length, to minimize the drift angle immediately after takeoff. Begin the takeoff with ailerons fully deflected into the wind. As the airplane is accelerated, reduce aileron deflection maintaining directional control down the runway. Reaching a speed slightly higher than normal rotation speed, apply gentle back pressure to the elevator control and quickly, but carefully, lift the airplane off the ground. Do not over rotate but keep positive pitch angle and airspeed to prevent possible settling back to the runway. When well clear of the ground, make a coordinated turn into the wind to correct for drift.

ENROUTE CLIMB

Normal enroute climbs are performed with flaps up, at full throttle and 65 to 75 KIAS for the best combination of performance, visibility and engine cooling. The mixture should be full rich during climb at altitudes up to 5000 feet pressure altitude. Above 5000 feet pressure altitude, the mixture can be leaned as needed for increased power or to provide smoother engine operation.

If it is necessary to climb more rapidly to clear mountains or reach favorable winds at higher altitudes, the best rate of climb speed is 62 KIAS and should be used with Maximum Continuous Power (MCP).

If an obstruction dictates the use of a steep climb angle, the best angle of climb speed is 57 KIAS and should be used with flaps UP and MCP. This type of climb should be of the minimum duration and engine temperatures should be carefully monitored due to the low climb speed.

CRUISE

Normal cruise is performed between 40% and 75% power. The engine RPM and corresponding fuel consumption for various altitudes can be determined by using the data in Section 5.

NOTE

Cruise flight should use 75% power as much as possible until the engine has operated for a total of 50 hours or oil consumption has stabilized. Operation at this higher power will ensure proper seating of the piston rings and is applicable to new engines, and engines in service following cylinder replacement or top overhaul of one or more cylinders.

The Cruise Performance charts in Section 5 provide the pilot with flight planning information for the Model 162 in still air at maximum gross weight without speed fairings installed. Cruise performance may differ slightly due to differences in weight and center of gravity location.

The Cruise Performance charts should be used as a guide, along with the available winds aloft information, to determine the most favorable altitude, power setting and fuel needed for a given flight.

The selection of cruise altitude on the basis of the most favorable wind conditions and the use of low power settings are significant factors that should be considered on every trip to reduce fuel consumption.

Proper leaning techniques also contribute to greater range and are figured into cruise performance tables. To achieve the recommended lean mixture fuel consumption figures shown in Section 5, the mixture should be leaned per recommended procedures.

In the event that unusual conditions cause the intake air filter to become clogged or iced over, apply carburetor heat immediately to bypass the intake air filter therefore providing unfiltered heated air as the alternate air intake. Engine RPM can decrease from a cruise power setting. This RPM loss should be recovered by increasing the throttle setting to maintain desired power.

(Continued Next Page)

CRUISE (Continued)

Carburetor ice, as evidenced by an unexplained drop in RPM, can be removed by application of full carburetor heat. Upon regaining the original RPM (with heat off), use the minimum amount of heat (reference EIS CARB °F display) to prevent ice from forming. Since the heated air causes a richer mixture, readjust the mixture setting when carburetor heat is to be used continuously in cruise flight.

The use of full carburetor heat is recommended during flight in heavy rain to avoid the possibility of engine stoppage due to excessive water ingestion or carburetor ice. The mixture setting should be readjusted for smoothest operation. Power changes should be made cautiously, followed by prompt adjustment of the mixture for smoothest operation.

LEANING WITHOUT EXHAUST GAS TEMPERATURE (EGT) INDICATOR

BEST POWER CRUISE

Use the mixture control vernier adjustment to lean the fuel mixture by slowly turning the mixture control knob in the counterclockwise direction while monitoring engine RPM. As RPM increases, continue to carefully lean the mixture until it reaches peak RPM. Slightly enrichen mixture (turn mixture control knob clockwise) until a slight drop in engine RPM is indicated. This is the Best Power Cruise setting.

CAUTION

EXCESSIVE LEANING WILL INCREASE ENGINE TEMPERATURES AND MAY DAMAGE ENGINE. WHEN INCREASING POWER, ENRICHEN MIXTURE, THEN ADVANCE THE THROTTLE TO INCREASE RPM. WHEN REDUCING POWER, RETARD THROTTLE, THEN ADJUST THE MIXTURE CONTROL.

Lean the mixture for maximum RPM during all operations at any altitude, including those below 3000 feet, when using 75% or less power. Above 5000 feet, mixture may be leaned for maximum RPM during full throttle climbs (after engine has accumulated 50 hours).

(Continued Next Page)

CRUISE (Continued)

LEANING WITH EXHAUST GAS TEMPERATURE (EGT) INDICATOR (if installed)

The cruise performance data in this POH is based on the recommended lean mixture setting determined from the maximum or peak EGT at power settings of 75% MCP and lower.

EGT °F is displayed with a vertical scale and pointer on the EIS ENGINE page. The numerical value for the EGT is located above the vertical scale.

Use the mixture control vernier adjustment to lean the fuel mixture by slowly turning the mixture control knob in the counterclockwise direction while monitoring EGT. As EGT °F increases, continue to lean the mixture until it reaches peak EGT. Enrichen the mixture by slowly turning the mixture control clockwise and monitor EGT °F until EGT decreases slightly.

NOTE

The Model 162 engine manufacturer, Teledyne Continental Motors, has not approved operation of the engine at fuel flow rates (mixture settings) less than necessary to reach peak EGT. Refer to Section 5, Figure 5-7, Cruise Performance, for specific power settings and lean for best power cruise.

Continuous operation at mixture settings lean of peak EGT is prohibited.

(Continued Next Page)

CRUISE (Continued)

LEANING WITH EXHAUST GAS TEMPERATURE (EGT) INDICATOR (if installed) (Continued)

CAUTION

EXCESSIVE LEANING WILL INCREASE ENGINE TEMPERATURES AND MAY DAMAGE ENGINE. WHEN INCREASING POWER, ENRICHEN MIXTURE, THEN ADVANCE THE THROTTLE TO INCREASE RPM. WHEN REDUCING POWER, RETARD THROTTLE, THEN ADJUST THE MIXTURE CONTROL.

NOTE

- Any change in altitude or power setting will require a change in the recommended lean mixture setting and a recheck of the EGT setting.
- The EGT indicator takes several seconds, after a mixture adjustment, to start to show an EGT change. Finding peak EGT and adjusting the mixture to the applicable setting should take approximately one minute when the adjustments are made carefully and accurately. Adjusting the mixture quickly is not recommended.

(Continued Next Page)

CRUISE (Continued)

FUEL SAVINGS PROCEDURES FOR FLIGHT TRAINING OPERATIONS

For best fuel economy during flight training operations, the following procedures are recommended.

1. After engine start and for all ground operations, set the throttle to 1200 RPM and lean the mixture for maximum RPM. After leaning, set the throttle to the appropriate RPM for ground operations. Leave the mixture at this setting until beginning the BEFORE TAKEOFF checklist. If TAKEOFF is delayed after completing the BEFORE TAKEOFF checklist, lean the mixture again as described above until ready to perform the TAKEOFF checklist.
2. Lean the mixture for maximum RPM during full throttle climbs above 5000 feet. The mixture may remain leaned (maximum RPM at full throttle) for practicing maneuvers such as stalls and slow flight.
3. Lean the mixture for maximum RPM during all operations at any altitude, including those below 3000 feet, when using 75% or less power.

NOTE

- When cruising or maneuvering at 75% power or less, the mixture may be further leaned to best power cruise. This is especially applicable to cross-country training flights, but should be practiced during transition flight to and from the practice area as well.
- Using the above recommended procedures can provide fuel savings in excess of 5% when compared to typical training operations at full rich mixture. In addition, the above procedures will minimize spark plug fouling since the reduction in fuel consumption results in a proportional reduction in tetraethyl lead passing through the engine.

STALLS

The stall characteristics are conventional for the flaps up and flaps down conditions and aural warning is provided by a stall warning horn which sounds between 5 and 10 knots above the stall in all configurations. Power-on stall recovery should be initiated by simultaneously lowering the nose while reducing power after which normal power-off stall recovery techniques should be applied.

CAUTION

INTENTIONAL POWER-ON STALLS SHOULD BE LIMITED TO 30 DEGREES NOSE UP PITCH ANGLE. EXCEEDING 30 DEGREES REQUIRES HIGH POWER AND ACCELERATED STALL ENTRY WHICH MAY RESULT IN DISORIENTATION

WARNING

INTENTIONAL SPINS ARE PROHIBITED. REFER TO SECTION 6, EMERGENCY PROCEDURES, SPINS. IT IS RECOMMENDED THAT THESE EMERGENCY PROCEDURES BE MEMORIZED TO ENSURE PROMPT AND PROPER RECOVERY TECHNIQUES ARE USED IN THE EVENT AN INADVERTENT SPIN IS ENCOUNTERED.

Refer to Section 5, Figure 5-2, for power-off stall speeds at 1320 pounds.

DESCENT

Normal descent from altitude may be made with flaps retracted or with flaps extended to increase drag for a steepened descent angle. Caution should be used to observe flap limit speeds. Slips may be made in all flap configurations and are useful to increase descent rates while allowing power to be kept above idle. Carburetor heat should be used as needed for engine roughness and applied before reducing power to prevent carburetor ice from forming during low power descent. Since heated air causes a richer fuel mixture, readjust the mixture setting when carburetor heat is to be used for extended descent. If a low power descent is made, it is recommended that the throttle be cycled occasionally to check for engine roughness at higher power.

NOTE

Extended low power descents should be avoided during the first 25 hours of operation of a new engine.

LANDING

NORMAL LANDING

Normal landing approaches can be made with power on or power off with any flap setting within the flap airspeed limits. Surface winds and air turbulence are usually the primary factors in determining the most comfortable approach speeds. Slips to landing are very effective may be performed in all flap configurations.

Landing at slower speeds will result in shorter landing distances and minimum wear to tires and brakes. Power should be at idle as the main wheels touch the ground. The main wheels must touch the ground before the nosewheel. The nosewheel must be lowered to the runway carefully after the speed has diminished to avoid unnecessary nose gear loads. This procedure is very important for rough or soft field landings. Directional control should be maintained using up to full rudder deflection and differential braking as necessary.

SHORT FIELD LANDING

For a short field landing in smooth air conditions, approach at 50 KIAS with FULL flaps using enough power to control the glide path. Slightly higher approach speeds should be used in turbulent air conditions. After all approach obstacles are cleared, smoothly reduce power and hold the approach speed by lowering the nose of the airplane. The main wheels must touch the ground before the nosewheel with power at idle. Immediately after the main wheels touch the ground, carefully lower the nosewheel and apply heavy braking as required. For maximum brake performance, retract the flaps, hold the control stick full back, and apply maximum brake pressure without skidding the tires or losing directional control. Use of full rudder authority will assist directional control.

(Continued Next Page)

LANDING (Continued)

CROSSWIND LANDING

When landing in a strong crosswind, use the minimum flap setting required for the field length. Sideslips with full rudder deflection, may be made in all flap configurations. Although the crab or combination method of drift correction may be used, the wing low method gives the best control. After touchdown, hold a straight course with the rudder and use up to full aileron deflection as required, and differential braking as necessary.

The maximum allowable crosswind velocity is dependent upon pilot capability as well as airplane limitations. Operation in direct crosswinds of 12 knots has been demonstrated (not an operating limitation).

BALKED LANDING

In a balked landing (go-around) climb, reduce the flap setting to 25° immediately after full power is applied and climb at 50 KIAS. Above 3000 feet pressure altitude, lean the mixture to obtain maximum RPM. After clearing any obstacles, allow the airplane to accelerate to 60 KIAS and carefully retract the flaps to 10°. After clearing any obstacles, carefully retract the flaps and allow the airplane to accelerate to normal climb airspeed.

HIGH WIND OPERATIONS

Takeoff and landings have been demonstrated in winds up to 22 knots and crosswinds up to 12 knots. The pilot should be cautious of gusts and turbulence from terrain or buildings when in close proximity to ground during takeoff and landing. Prompt and positive control inputs should be used to counter flight path deviations.

Proper taxi control techniques must be used at all times during ground operations. Operations in wind conditions above 22 knots are not recommended.

COLD WEATHER OPERATIONS

Special consideration should be given to the operation of the airplane fuel system during the winter season or prior to any flight in cold temperatures. Proper preflight draining of the fuel system is especially important and will eliminate any free water accumulation. The use of additives such as isopropyl alcohol or Diethylene Glycol Monomethyl Ether (DIEGME) may also be desirable. Refer to Section 8, Fuel Additives, for more information on the proper use of fuel additives.

Cold weather often causes conditions that require special care during airplane operations. **Even small accumulations of frost, ice, or snow must be removed, particularly from wing, tail and all control surfaces to assure satisfactory flight performance and handling.** Also, control surfaces must be free of any internal accumulations of ice or snow.

If snow or slush covers the takeoff surface, allowance must be made for takeoff distances which will be increasingly extended as the snow or slush depth increases. The depth and consistency of this cover can, in fact, prevent takeoff in many instances.

The Garmin G300 Instrumentation Liquid Crystal Displays (LCD) may acquire a frosted or cloudy appearance at extremely cold temperatures. The displays may also be very slow to update information when cold soaked. Proper flight display clarity and flight data update rates may require extended warm-up.

The Garmin G300 EIS engine information is recommended for engine start due to possibility of engine damage resulting from inability to monitor engine upon start.

Takeoff is not recommended until displays are clearly legible and information updates (as indicated by heading change during taxi, RPM changes with throttle, etc) are shown in real-time without hesitation.

The Garmin G300 display warm-up is best accomplished by placing the airplane in a warm hangar and leaving the cabin doors open. If a hangar is not available, attach External Power (if installed) and set the MASTER Switch (BAT) and AVN MASTER Switch to the ON position. Allow display units to warm internally until legible and display controls (softkeys and knob) function normally when operated.

(Continued Next Page)

COLD WEATHER OPERATIONS (Continued)

NOTE

If external power is not available, do not attempt the self warming procedure. The battery will likely become depleted below the minimum voltage necessary for engine start.

External warm-air preheat may be applied to the cabin area. Use caution as excessively hot preheated air may damage interior or instrumentation. Due to fuel lines routed through cabin area, gas fired or exposed flame heaters should not be used to warm the cabin area.

STARTING

When air temperatures are below 20°F (-6°C), use an external preheater and an external power source, if external power receptacle is installed, whenever possible to obtain positive starting and to reduce wear and abuse to both the engine and electrical system. Preheat will thaw the oil trapped in the oil cooler, which probably will be congealed prior to starting in extremely cold temperatures.

WARNING

WHEN TURNING THE PROPELLER BY HAND, TREAT IT AS IF THE MAGNETOS SWITCH IS IN THE ON POSITION. A LOOSE OR BROKEN GROUND WIRE ON EITHER MAGNETO COULD ENERGIZE THE ENGINE.

Prior to starting on cold mornings, it is advisable to turn the propeller manually through several engine compression cycles by hand to loosen the oil, so the engine cranks (motors) more easily and uses less battery power. When the propeller is turned manually, turn it in the opposite direction to normal engine rotation for greater safety. Opposite rotation disengages the magneto impulse couplings and prevents possible unwanted ignition.

When using an external power source, the MASTER Switch (ALT and BAT) sections must be in the OFF position before connecting the external power source to the external power receptacle. Refer to Section 7, Starting Engine with External Power, for system description and operations.

(Continued Next Page)

COLD WEATHER OPERATION (Continued)

STARTING (Continued)

Cold weather starting procedures are the same as the normal starting procedures. Refer to Amplified Normal Procedures, Starting Engine in this section. The amount of fuel priming required for engine start is dependant upon temperature. The colder the engine, the more prime is required. In extremely cold temperatures, it may be necessary to continue priming while cranking the engine. If the engine is under primed it will not fire at all, and additional priming will be necessary. As soon as the cylinders begin to fire, open the throttle slightly to keep it running. Use caution to prevent inadvertent forward movement of the airplane during starting when parked on snow or ice.

CAUTION

HEAVY PRIMING AND THROTTLE PUMPING DURING START INCREASES THE RISK OF INDUCTION SYSTEM FIRE RESULTING FROM A BACKFIRE OR OTHER ABNORMALITY DURING START. IN THE EVENT OF AN ENGINE FIRE, CONTINUE CRANKING TO SUCK THE FLAMES INTO THE ENGINE. REFER TO SECTION 6, EMERGENCY PROCEDURES, FIRES, DURING START ON GROUND.

NOTE

If the engine does not start during the first few attempts, or if engine firing diminishes in strength, the spark plugs may be frosted over. Preheat must be used before another start is attempted.

(Continued Next Page)

COLD WEATHER OPERATION (Continued)

STARTING (Continued)

During cold weather operations, the oil temperature indicator may not be in the green band range when ready to perform the BEFORE TAKEOFF checklist if outside air temperatures are very cold. After a suitable warm up period of 2 to 5 minutes at 1000 RPM, slowly accelerate the engine to higher engine RPM. The engine should not exceed 1700 RPM until oil temperature indicates more than 75°F (24°C) and oil pressure is within the green band range (30 to 60 PSI). Once engine oil pressure and oil temperature reach normal operating range perform the BEFORE TAKEOFF checklist followed by a immediate takeoff. If engine is allowed to idle for a extended period of time between the completion of the BEFORE TAKEOFF checklist and prior to TAKEOFF, oil temperature may fall below 75°F (24°C) requiring a slow engine acceleration to warm the engine oil prior to performing TAKEOFF.

WINTERIZATION KIT

An optional winterization kit is available and may be utilized when cold weather operations are conducted. Refer to Section 10, Supplement 4 for installation and operational details.

HOT WEATHER OPERATIONS

Refer to the general warm engine starting information under Starting Engine in this section. Cabin doors may be left open for engine start and taxi if desired to aid cabin cooling. Face the airplane into the wind when possible for additional cooling airflow and avoid prolonged engine operation on the ground. Cabin doors must be closed for flight.

AIRPLANE HANDLING, SERVICE AND MAINTENANCE

TABLE OF CONTENTS

	Page
Introduction	8-3
Identification Plate	8-4
Cessna Owner Advisories	8-4
United States Airplane Owners	8-4
International Airplane Owners	8-4
Publications	8-5
Airplane File	8-7
Airplane Inspection Periods	8-8
FAA Required Inspections	8-8
Cessna Inspection Programs	8-8
Cessna Customer Care Program	8-8
Pilot Conducted Preventive Maintenance	8-9
Alterations Or Repairs	8-9
Ground Handling	8-10
Towing	8-10
Parking	8-11
Tiedown	8-11
Jacking	8-12
Leveling	8-13
Flyable Storage	8-13
Servicing	8-14
Oil	8-15
Oil Specification	8-15
Recommended Viscosity For Temperature Range	8-15
Capacity Of Engine Sump	8-16
Oil And Oil Filter Change	8-16

(Continued Next Page)

TABLE OF CONTENTS (Continued)

	Page
Fuel	8-17
Approved Fuel Grades (And Colors)	8-17
Fuel Capacity	8-17
Fuel Additives	8-18
Fuel Contamination	8-21
Landing Gear	8-22
Cleaning And Care	8-22
Windshield And Windows	8-22
Painted Surfaces	8-23
Propeller Care	8-24
Engine Care	8-24
Interior Care	8-25/8-26
Avionics Care	8-25/8-26

INTRODUCTION

This section contains factory recommended procedures for proper ground handling and routine care and servicing of your airplane. It also identifies certain inspection and maintenance requirements which must be followed if your airplane is to retain that new airplane performance and dependability. It is important to follow a planned schedule of lubrication and preventive maintenance based on climatic and flying conditions encountered in your local area.

Keep in touch with a Cessna Service Station and take advantage of their knowledge and experience. Your Cessna Service Station knows your airplane and how to maintain it, and will remind you when lubrications and oil changes are necessary, as well as other seasonal and periodic services.

The airplane should be regularly inspected and maintained in accordance with information found in the airplane maintenance manual and in company issued Service Bulletins, Safety Alerts and Service Newsletters. All service bulletins pertaining to the airplane by serial number should be accomplished and the airplane should receive repetitive and required inspections. Modifications not approved by Cessna may void warranties on the airplane since Cessna has no way of knowing the full effect on the overall airplane. Operation of an airplane that has been modified may be a risk to the occupants, and operating procedures and performance data set forth in the POH may no longer be considered accurate for the modified airplane.

IDENTIFICATION PLATE

All correspondence regarding your airplane should include the Serial Number. The Serial Number, Model Number and ASTM Standard Number can be found on the Identification Plate, located on the aft left tailcone.

CESSNA OWNER ADVISORIES

Cessna Owner Advisories are sent to Cessna Aircraft FAA Registered owners of record at no charge to inform them about Safety Alerts, mandatory Notice of Corrective Actions and/or beneficial airplane service requirements and product changes. Copies of the actual bulletins are available from Cessna Service Stations and Cessna Propeller Aircraft Customer Services.

UNITED STATES AIRPLANE OWNERS

If your airplane is registered in the U.S., appropriate Cessna Owner Advisories will be mailed to you automatically according to the latest airplane registration name and address which you have provided to Cessna. Therefore, it is important that you provide correct and up to date mailing information to Cessna.

If you require a duplicate Owner Advisory to be sent to an address different from the aircraft registration address on file at Cessna, please complete and return an Owner Advisory Application (otherwise no action is required on your part).

INTERNATIONAL AIRPLANE OWNERS

To receive Cessna Owner Advisories, please complete and return an Owner Advisory Application.

PUBLICATIONS

Various publications and flight operation aids are furnished in the airplane when delivered from the factory. These items are listed below.

- Pilot's Operating Handbook and Flight Training Supplement
- Pilot's Checklist
- Garmin G300 Pilot's Guide 190-00921-00 (latest revision)
- Garmin G300 Cockpit Reference Guide (CRG) (latest revision)
- Passenger Briefing Card
- Customer Care Handbook

To obtain additional publications or owner advisory information, you may contact Cessna Customer Service at (316) 517- 5800, Fax (316) 517-7271 or write to Cessna Aircraft Company, P.O. Box 7706, Wichita, KS 67277, Dept 569C.

To obtain additional Garmin publications, you may contact Garmin Customer Service at Garmin International, Inc, (913) 397-8200, Fax (913) 397-8282, 1200 East 151st Street, Olathe, Kansas 66062, USA or visit the Garmin website (www.Garmin.com) for current updates and supplemental information.

The following additional publications, plus many other supplies that are applicable to your airplane, are available from a Cessna Service Station.

- Information Manual (contains Pilot's Operating Handbook Information)
- Maintenance Manual, Wiring Diagram Manual and Illustrated Parts Catalog

(Continued Next Page)

PUBLICATIONS (Continued)

Cessna Service Stations have a Customer Care Supplies and Publications Catalog covering all available items, many of which the Service Station keeps on hand. The Service Station can place an order for any item which is not in stock.

NOTE

A Pilot's Operating Handbook which is lost or destroyed may be replaced by contacting a Cessna Service Station.

AIRPLANE FILE

There are miscellaneous data, information and licenses that are a part of the airplane file. The following is a checklist for that file. In addition, a periodic check should be made of the latest Federal Aviation Regulations to ensure that all data requirements are met.

To be displayed in the airplane at all times:

1. Aircraft Special Airworthiness Certificate (FAA Form 8130-7)
2. Aircraft Registration Certificate (FAA Form 8050-3)
3. Aircraft Radio Station License, (if applicable)

To be carried in the airplane at all times:

1. Current Pilot's Checklist

Recommended to be carried in the airplane at all times:

1. Current Pilot's Operating Handbook and Flight Training Supplement
2. Garmin G300 Pilot's Guide 190-00921-00 (latest revision)
3. Garmin G300 Cockpit Reference Guide (CRG) (latest revision)
4. Weight and Balance, and associated papers
5. Equipment List

To be made available upon request:

1. Airframe Logbook
2. Engine Logbook
3. Propeller Logbook

Most of the items listed are required by the United States Federal Aviation Regulations. Since the regulations of other nations may require other documents and data, owners of airplanes not registered in the United States should check with their own aviation officials to determine their individual requirements.

Cessna recommends that these items, plus the Customer Care Handbook and Customer Care Card, be carried in the airplane at all times.

AIRPLANE INSPECTION PERIODS

FAA REQUIRED INSPECTIONS

As required by U.S. Federal Aviation Regulations, all civil aircraft of U.S. registry must undergo a complete inspection (annual) each twelve calendar months. In addition to the required annual inspection, aircraft operated for in-flight instruction must have a complete inspection every 100 hours of operation.

Cessna and the FAA may require other inspections by the issuance of Service Bulletins, Safety Alerts and Airworthiness Directives applicable to the airplane, engine, propeller and components. It is the responsibility of the owner/operator to ensure compliance with all applicable Service Bulletins, Safety Alerts and Airworthiness Directives and when the inspections are repetitive, to take appropriate steps to prevent inadvertent noncompliance.

CESSNA INSPECTION PROGRAMS

Airplane owners should keep in mind that 14 CFR 61 and 14 CFR 65 establishes the requirement that properly certified agencies or personnel accomplish all required FAA inspections and most of the manufacturer recommended inspections.

CESSNA CUSTOMER CARE PROGRAM

Specific benefits and provisions of the Cessna Warranty plus other important benefits for you are contained in your Customer Care Handbook supplied with your airplane. The Customer Care Handbook should be thoroughly reviewed and kept in the airplane at all times.

You will also want to return to your Cessna Service Station at 25, 50 and 100 hours inspections. These important inspections will be performed for you by any Cessna Service Station, in most cases you will prefer to have the Cessna Service Station from whom you purchased the airplane accomplish this work.

PILOT CONDUCTED PREVENTIVE MAINTENANCE

A certified pilot who owns or operates an airplane not used as an air carrier is authorized by 14 CFR 43 to perform limited maintenance on his/her airplane. Refer to 14 CFR 43 for a list of the specific maintenance operations which are allowed.

NOTE

Pilots operating airplanes of other than U.S. registry should refer to the regulations of the country of certification for information on preventive maintenance that may be performed by pilots.

A current Maintenance Manual must be obtained prior to performing any preventive maintenance to ensure that proper procedures are followed. A Cessna Service Station should be contacted for further information or for required maintenance which must be accomplished by appropriately licensed personnel.

ALTERATIONS OR REPAIRS

It is essential that a Cessna Service Station be contacted prior to any alterations on the airplane to ensure that airworthiness of the airplane is not violated. Alterations or repairs to the airplane must be accomplished by licensed personnel, utilizing only Cessna Aircraft Company Approved components and Cessna Approved data, such as Cessna Service Bulletins, Cessna Approved Modification Kits and/or Cessna Approved Maintenance Manuals.

GROUND HANDLING

TOWING

The airplane is most easily and safely maneuvered by hand with a tow bar attached to the nosewheel. When towing with a vehicle, do not exceed the nose gear turning angle of 57.5° either side of center, or damage to the nose landing gear will result.

CAUTION

REMOVE ANY INSTALLED RUDDER LOCK BEFORE TOWING.

If the airplane is towed or pushed over a rough surface during hangaring, watch that the normal cushioning action of the nose strut does not cause excessive vertical movement of the tail and the resulting contact with low hangar doors or structure. A flat nose tire will also increase tail height.

CAUTION

DO NOT APPLY PRESSURE ON THE ELEVATOR OR HORIZONTAL STABILIZER SURFACES. WHEN PUSHING ON THE TAILCONE, ALWAYS APPLY PRESSURE AT A FUSELAGE BULKHEAD TO AVOID BUCKLING THE SKIN.

(Continued Next Page)

GROUND HANDLING (Continued)

PARKING

When parking the airplane, head into the wind and set the parking brake. Failure to park into the wind may allow wing flaps to blow down randomly. If forced to park with the tail into the wind, place the flaps FULL down and secure the airplane per the TIEDOWN procedure. Do not set the parking brake during cold weather when accumulated moisture may freeze the brakes, or when the brakes are overheated. Install the control stick lock and chock the wheels. In severe weather and high wind conditions, tie the airplane down as outlined in the following paragraph.

TIEDOWN

Proper tiedown procedure is the best precaution against damage to the parked airplane by gusty or strong winds. To tiedown the airplane securely, proceed as follows:

1. Set the parking brake and install the control wheel lock.
2. Install a surface control lock over the fin and rudder.
3. Tie sufficiently strong ropes or chains (700 pounds tensile strength) to the wing, tail and nose tiedown fittings and secure each rope or chain to a ramp tiedown.
4. Install a pitot tube cover.

(Continued Next Page)

GROUND HANDLING (Continued)

JACKING

When a requirement exists to jack the entire airplane off the ground, or when wing jack points are used in the jacking operation, refer to the Maintenance Manual for specific procedures and equipment required.

Individual main gear may be jacked by using the jack pad which is incorporated in the main landing gear strut. When using the individual gear strut jack pad, flexibility of the gear strut may cause the main wheel to slide inboard as the wheel is raised, tilting the jack. The jack must then be lowered for a second jacking operation. Do not jack both main wheels simultaneously using the individual main gear jack pads.

CAUTION

DO NOT APPLY PRESSURE ON THE ELEVATOR OR HORIZONTAL STABILIZER SURFACES. WHEN PUSHING ON THE TAILCONE, ALWAYS APPLY PRESSURE AT A FUSELAGE BULKHEAD TO AVOID BUCKLING THE SKIN.

If nose gear maintenance is required, the nosewheel may be raised off the ground by pressing down on a aft fuselage tailcone bulkhead, just forward of the horizontal stabilizer, and allowing the tail to rest on the tail tiedown ring.

To assist in raising and holding the nosewheel off the ground, ground anchors should be utilized at the tail tiedown point.

NOTE

Ensure that the nose will be held off the ground under all conditions by means of suitable stands or supports under weight supporting bulkheads near the nose of the airplane or the engine truss mount.

(Continued Next Page)

GROUND HANDLING (Continued)

LEVELING

Longitudinal leveling of the airplane is accomplished by placing a level on leveling screws located on the left side of the tailcone. Deflate the nose tire and raise the main landing gear to properly center the bubble in the level. The fuselage wing carry through spar in the cabin may be used to level the airplane laterally.

FLYABLE STORAGE

Engines in airplanes that are flown every 30 days or less may not achieve normal service life because of internal corrosion. Corrosion occurs when moisture from the air and the products of combustion combine to attack cylinder walls and bearing surfaces during periods when the airplane is not flown.

The minimum recommended operating frequency for the engine is one continuous flight hour (not counting taxi, takeoff and landing time) with oil temperatures of 170°F to 220°F every 30 days or less (depending on location and storage conditions). Airplanes operated close to oceans, lakes, rivers and in humid regions are in greater need of engine preservation than airplanes operated in arid regions. Appropriate engine preservation procedures must be practiced by the owner or operator of the airplane based on present environmental conditions and the frequency of airplane activity.

NOTE

The engine manufacturer does not recommend pulling the engine through by hand during storage periods.

If the airplane is to remain inactive for more than 30 days, consult the latest revision of Teledyne Continental Motors (TCM) Service Information Letter SIL99-1 or later revision (www.tcmlink.com).

It is recommended when storing the airplane for any period of time to keep fuel tanks full to minimize condensation in tanks. Keep the battery fully charged to prevent the electrolyte from freezing in cold weather. Refer to the Maintenance Manual for proper airplane storage procedures.

SERVICING

In addition to the Preflight Inspection covered in Section 7 of this POH, complete servicing, inspection and test requirements for your airplane are detailed in the Maintenance Manual. The Maintenance Manual outlines all items which require attention at specific intervals plus those items which require servicing, inspection, and/or testing at special intervals.

Since Cessna Service Stations conduct all service, inspection, and test procedures in accordance with applicable Maintenance Manuals, it is recommended that you contact a Cessna Service Station concerning these requirements and begin scheduling your airplane for service at the recommended intervals.

Depending on various flight operations, your local government aviation agency may require additional service, inspections, or tests. For these regulatory requirements, owners should check with local aviation officials where the airplane is being operated.

For quick and ready reference, quantities, materials and specifications for frequently used service items are as follows.

OIL

OIL SPECIFICATION

SAE J1966 Aviation Grade Non-Dispersant Mineral Oil: Used when the airplane was delivered from the factory and should be used to replenish the supply during the first 25 hours. This oil should be drained and the filter changed after the first 25 hours of operation. Refill the engine with SAE J1966 Aviation Grade Non-Dispersant Mineral Oil and continue to use until a total of 50 hours has accumulated or oil consumption has stabilized.

SAE J1899 Aviation Grade Ashless Dispersant Oil: Oil conforming to Teledyne Continental Motors (TCM) Service Information Letter SIL99-2B, and all revisions and supplements thereto, **must be used** after first 50 hours or oil consumption has stabilized.

RECOMMENDED VISCOSITY FOR TEMPERATURE RANGE

Multiviscosity or straight grade oil may be used throughout the year for engine lubrication. Refer to the following table for temperature versus viscosity ranges.

Temperature	SAE J1966 Non-Dispersant Mineral Oil SAE Grade	SAE J1899 Ashless Dispersant Oil SAE Grade
Above 4°C (40°F)	50	50, 15W-50, 20W-50 or 25W-60
Below 4°C (40°F)	30	30, 15W-50, 20W-50 or 25W-60
All Temperatures	M20W-50	15W-50, 20W-50 or 25W-60

NOTE

When operating temperatures overlap, use the lighter grade of oil.

(Continued Next Page)

OIL (Continued)

CAPACITY OF ENGINE SUMP

The engine has a total capacity of 5.5 U.S. quarts, with the oil filter accounting for approximately 0.33 U.S. quarts of that total. The engine must not be operated on less than 3.5 U.S. quarts (as measured by the dipstick). For extended flights, the engine should be filled to capacity.

OIL AND OIL FILTER CHANGE

After the first 25 hours of operation, drain the engine oil sump and replace the filter. Refill sump with non-dispersant mineral oil and use until a total of 50 hours has accumulated or oil consumption has stabilized; then change to ashless dispersant oil. Ashless dispersant oil (and oil filter) should be changed at time intervals set forth by the engine manufacturer.

NOTE

During the first 25 hour oil and filter change, a general inspection of the overall engine compartment is required. Items which are not normally checked during a preflight inspection should be given special attention. Hoses, metal lines and fittings should be inspected for signs of oil and fuel leaks, and checked for abrasions, chafing, security, proper routing and support, and evidence of deterioration. Inspect the intake and exhaust systems for cracks, evidence of leakage, and security of attachment. Engine controls and linkages should be checked for freedom of movement through their full range, security of attachment and evidence of wear. Inspect wiring for security, chafing, burning, defective insulation, loose or broken terminals, heat deterioration, and corroded terminals. A periodic check of these items during subsequent servicing operations is recommended.

FUEL

APPROVED FUEL GRADES (AND COLORS)

- 100LL Grade Aviation Fuel (Blue)
- 100 Grade Aviation Fuel (Green)

NOTE

Isopropyl alcohol or Diethylene Glycol Monomethyl Ether (DiEGME) may be added to the fuel supply in quantities not to exceed 1% (alcohol) or 0.15% (DiEGME) of total volume. Refer to Fuel Additives in later paragraphs for additional information.

FUEL CAPACITY

Total Capacity	25.46 U.S. GALLONS (96.34 l)
Total Usable	24.00 U.S. GALLONS (90.82 l)
Total Capacity Each Tank	12.73 U.S. GALLONS (48.17 l)
Total Usable Each Tank.	12.00 U.S. GALLONS (45.41 l)

NOTE

- To ensure maximum fuel capacity and minimize crossfeeding when refueling, always park the airplane in a wings level, normal ground attitude. Refer to Figure 1-1 for normal ground attitude dimensions.
- The fuel filler assembly is equipped with indicator tabs for 3/4, 1/2 and 1/4 fuel quantities.
- Maximum full capacity is indicated when fuel reaches the upper hole of the indicator tab. This fuel level allows for proper thermal expansion. Filling the fuel tank above the upper hole eliminates expansion space resulting in fuel venting overboard through the fuel vent.

(Continued Next Page)

FUEL (Continued)

FUEL ADDITIVES

Strict adherence to recommended preflight draining instructions as called for in Section 7 will eliminate any free water accumulations from the tank sumps. While small amounts of water may still remain in solution in the gasoline, it will normally be consumed and go unnoticed in the operation of the engine.

One exception to this can be encountered when operating under the combined effect of: (1) use of certain fuels, with (2) high humidity conditions on the ground (3) followed by flight at high altitude and low temperature. Under these unusual conditions, small amounts of water in solution can precipitate from the fuel stream and freeze in sufficient quantities to induce partial icing of the engine fuel system.

While these conditions are quite rare and will not normally pose a problem to owners and operators, they do exist in certain areas of the world and consequently must be dealt with, when encountered.

Therefore, to help alleviate the possibility of fuel icing occurring under these unusual conditions, it is permissible to add isopropyl alcohol or Diethylene Glycol Monomethyl Ether (DiEGME) compound to the fuel supply.

The introduction of alcohol or DiEGME compound into the fuel provides two distinct effects: (1) it absorbs the dissolved water from the gasoline and (2) alcohol has a freezing temperature depressant effect.

NOTE

When using fuel additives, it must be remembered that the final goal is to obtain a correct fuel to additive ratio in the tank, and not just with fuel coming out of the refueling nozzle. For example, adding 15 gallons of correctly proportioned fuel to a tank which contains 20 gallons of untreated fuel will result in a lower than acceptable concentration level to the 35 gallons of fuel which now reside in the tank.

(Continued Next Page)

FUEL (Continued)

FUEL ADDITIVES (Continued)

Alcohol, if used, is to be blended with the fuel in a concentration of 1% by volume. Concentrations greater than 1% are not recommended since they can be detrimental to fuel tank materials.

The manner in which the alcohol is added to the fuel is significant because alcohol is most effective when it is completely dissolved in the fuel. To ensure proper mixing, the following is recommended:

1. For best results, the alcohol should be added during the fueling operation by pouring the alcohol directly on the fuel stream issuing from the fueling nozzle.
2. An alternate method that may be used is to premix the complete alcohol dosage with some fuel in a separate clean container (approximately 2-3 gallon capacity) and then transferring this mixture to the tank prior to the fuel operation.

Diethylene Glycol Monomethyl Ether (DiEGME) compound must be carefully mixed with the fuel in concentrations between 0.10% (minimum) and 0.15% (maximum) of total fuel volume. Refer to Figure 8-1 for a DiEGME-to-fuel mixing chart.

WARNING

ANTI-ICING ADDITIVE IS DANGEROUS TO HEALTH WHEN BREATHED AND/OR ABSORBED INTO THE SKIN.

CAUTION

MIXING OF DIEGME WITH FUEL IS EXTREMELY IMPORTANT. A CONCENTRATION IN EXCESS OF THAT RECOMMENDED (0.15% BY VOLUME MAXIMUM) MAY RESULT IN DETRIMENTAL EFFECTS TO THE FUEL TANK AND SEALANT, AND DAMAGE TO O-RINGS AND SEALS USED IN THE FUEL SYSTEM AND ENGINE COMPONENTS. A CONCENTRATION OF LESS THAN THAT RECOMMENDED (0.10% BY TOTAL VOLUME MINIMUM) WILL RESULT IN INEFFECTIVE TREATMENT. USE ONLY BLENDING EQUIPMENT THAT IS RECOMMENDED BY THE MANUFACTURER TO OBTAIN PROPER PROPORTIONING.

(Continued Next Page)

FUEL (Continued)

FUEL ADDITIVES (Continued)

FUEL MIXING RATIO

B14781

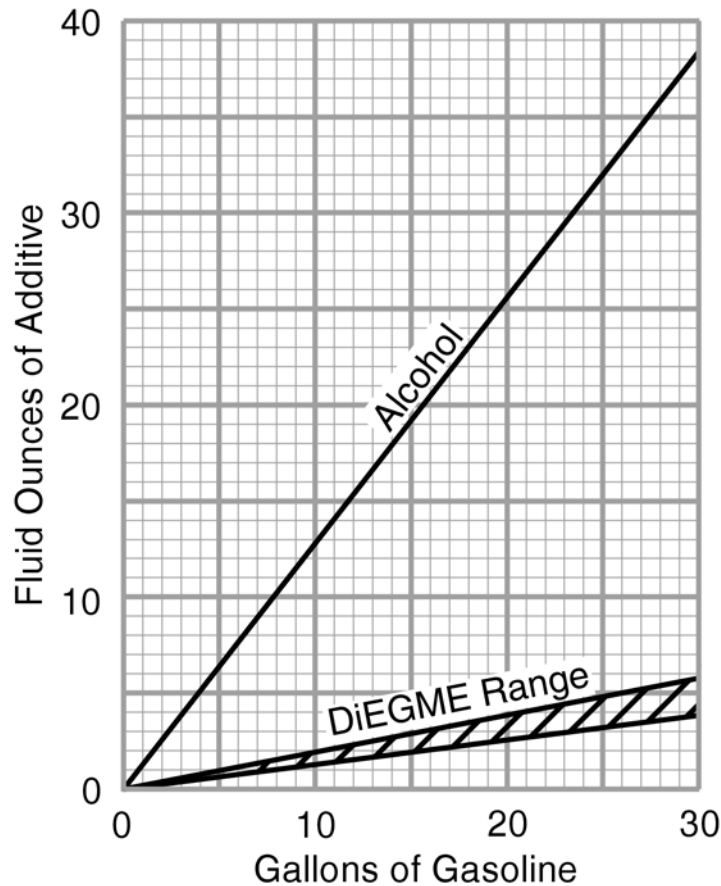

Figure 8-1*

Prolonged storage of the airplane will result in a water buildup in the fuel which leeches out the additive. An indication of this is when an excessive amount of water accumulates in the fuel tank sumps. The concentration can be checked using a differential refractometer. It is imperative that the technical manual for the differential refractometer be followed explicitly when checking the additive concentration.

(Continued Next Page)

FUEL (Continued)

FUEL CONTAMINATION

Fuel contamination is usually the result of foreign material present in the fuel system, and may consist of water, rust, sand, dirt, microbes or bacterial growth. In addition, additives that are not compatible with fuel or fuel system components can cause the fuel to become contaminated.

Before each flight and after each refueling, use a clear sampler cup and drain at least a cupful of fuel from each fuel tank drain location and from the fuel strainer quick drain valve to determine if contaminants are present, and to ensure the airplane has been fueled with the proper grade of fuel.

If contamination is detected, drain **all** fuel drain points again, including the fuel strainer and fuel sump valve, and then gently rock the wings and lower the tail to the ground to move any additional contaminants to the sampling points. Take repeated samples from all fuel drain points until **all** contamination has been removed. If, after repeated sampling, evidence of contamination still exists, the airplane should not be flown. Tanks should be drained and system purged by qualified maintenance personnel. All evidence of contamination must be removed before further flight. If the airplane has been serviced with the improper fuel grade, defuel completely and refuel with the correct grade. Do not fly the airplane with contaminated or unapproved fuel.

In addition, Owners/Operators who are not acquainted with a particular fixed base operator should be assured that the fuel supply has been checked for contamination and is properly filtered before allowing the airplane to be serviced. Fuel tanks should be kept full between flights, provided weight and balance considerations will permit, to reduce the possibility of water condensing on the walls of partially filled tanks.

To further reduce the possibility of contaminated fuel, routine maintenance of the fuel system should be performed in accordance with the airplane Maintenance Manual. Only the proper fuel, as recommended in this POH, should be used, and fuel additives should not be used unless approved by Cessna and the Federal Aviation Administration.

LANDING GEAR

Consult the following table for servicing information on the landing gear.

COMPONENT	SERVICING CRITERIA
Nose Wheel (4.00-5, 8-Ply Rated Tire)	38.0 PSI +/- 2.0 PSI
Main Wheel (5.00-5, 4-Ply Rated Tire)	30.0 PSI +/- 2.0 PSI
Brakes	MIL-H-5606

CLEANING AND CARE

WINDSHIELD AND WINDOWS

The plastic windshield and windows should be cleaned with an airplane windshield cleaner. Apply the cleaner sparingly with soft cloths, and rub with moderate pressure until all dirt, oil scum and bug stains are removed. Allow the cleaner to dry, then wipe it off with soft flannel cloths. The inside of the windshield should be cleaned with a anti-fog cleaning agent.

CAUTION

NEVER USE GASOLINE, BENZENE, ALCOHOL, ACETONE, FIRE EXTINGUISHER, ANTI-ICE FLUID, LACQUER THINNER OR GLASS CLEANER TO CLEAN THE PLASTIC. THESE MATERIALS WILL ATTACK THE PLASTIC AND MAY CAUSE IT TO CRAZE.

If a windshield cleaner is not available, the plastic can be cleaned with soft cloths moistened with Stoddard solvent to remove oil and grease. Follow by carefully washing with a mild detergent and plenty of water. Rinse thoroughly, then dry with a clean moist chamois.

Do not rub the plastic with a dry cloth since this builds up an electrostatic charge which attracts dust. Waxing with a good commercial wax will finish the cleaning job. A thin, even coat of wax, polished out by hand with clean soft flannel cloths, will fill in minor scratches and help prevent further scratching.

Do not use a canvas cover on the windshield unless freezing rain or sleet is anticipated since the cover may scratch the plastic surface.

(Continued Next Page)

CLEANING AND CARE (Continued)

PAINTED SURFACES

The painted exterior surfaces of your new Cessna have a durable, long lasting finish.

Generally, the painted surfaces can be kept bright by washing with water and mild soap, followed by a rinse with water and drying with cloths or a chamois. Remove stubborn oil and grease with a cloth moistened with Stoddard solvent. Take special care to make sure that the exterior graphics are not touched by the solvent. For complete care of exterior graphics, refer to the Maintenance Manual.

CAUTION

HARSH OR ABRASIVE SOAPS OR DETERGENTS WHICH CAUSE CORROSION OR SCRATCHES SHOULD NEVER BE USED ON THE PAINTED ALUMINUM STRUCTURE.

To seal any minor surface chips or scratches and protect against corrosion, the airplane should be waxed regularly with a good automotive wax applied in accordance with the manufacturer's instructions. If the airplane is operated in a seacoast or other salt water environment, it must be washed and waxed more frequently to assure adequate protection. Special care should be taken to seal around rivet heads and skin laps, which are the areas most susceptible to corrosion. A heavier coating of wax on the leading edges of the wings and tail and on the cowl nose cap and propeller spinner will help reduce the abrasion encountered in these areas. Reapplication of wax will generally be necessary after cleaning with soap solution or after chemical deicing operations.

When the airplane is parked outside in cold climates and it is necessary to remove ice before flight, care should be taken to protect the painted surfaces during ice removal with chemical liquids. Isopropyl alcohol will satisfactorily remove ice accumulations without damaging the paint. However, keep the isopropyl alcohol away from the windshield and cabin windows since it will attack the plastic and may cause it to craze.

(Continued Next Page)

CLEANING AND CARE (Continued)

PROPELLER CARE

■ Preflight inspection should include inspection of the propeller blades for nicks and scratches. Small nicks on the propeller, particularly near the tips and on the leading edges, should be monitored.

WARNING

OPERATION WITH NICKS OR SCRATCHES IN THE LEADING EDGE GREATER THAN 0.125 INCHES MAY RESULT IN CRACKS OR FAILURE OF THE PROPELLER BLADE.

ENGINE CARE

The engine may be cleaned, using a suitable solvent, in accordance with instructions in the Maintenance Manual. Most efficient cleaning is done using a spray type cleaner. Before spray cleaning, ensure that protection is afforded for components which might be adversely affected by the solvent. Refer to the airplane Maintenance Manual for proper lubrication of controls and components after engine cleaning. The induction air filter should be replaced when its condition warrants, not to exceed 500 hours.

(Continued Next Page)

CLEANING AND CARE (Continued)

INTERIOR CARE

To remove dust and loose dirt from the upholstery and interior, clean the interior regularly with a vacuum cleaner.

Blot up any spilled liquid promptly with cleansing tissue or rags. Do not pat the spot; press the blotting material firmly and hold it for several seconds. Continue blotting until no more liquid is taken up. Scrape off sticky materials with a dull knife, then spot clean the area.

Oily spots may be cleaned with household spot removers, used sparingly. Before using any solvent, read the instructions on the container and test it on an obscure place on the fabric to be cleaned. Never saturate the fabric with a volatile solvent; it may damage the padding and backing materials.

Soiled upholstery may be cleaned with foam type detergent, used according to the manufacturer's instructions. To minimize wetting the fabric, keep the foam as dry as possible and remove it with a vacuum cleaner.

CAUTION

HARSH OR ABRASIVE SOAPS OR DETERGENTS WHICH CAUSE CORROSION OR SCRATCHES SHOULD NEVER BE USED ON THE PAINTED ALUMINUM STRUCTURE.

For complete information related to interior cleaning, refer to the Maintenance Manual.

AVIONICS CARE

The Garmin G300 and avionics displays have an anti-reflective coating that is very sensitive to skin oils, waxes, ammonia, and abrasive cleaners. Clean the displays as described in the G300 Pilot's Guide.

PLACARDS AND MARKINGS

TABLE OF CONTENTS

	Page
Airspeed Indicator Markings	9-3
Powerplant Instrument Markings	9-4
Placards	9-5

AIRSPEED INDICATOR MARKINGS

Airspeed indicator markings and their color code significance are shown in Figure 9-2.

AIRSPEED INDICATOR MARKINGS

MARKING	KIAS VALUE OR RANGE	SIGNIFICANCE
Red Band	<37	Low airspeed warning.
White Band	37 - 70	Full Flap Operating Range. Lower limit is maximum weight V_{SO} in landing configuration. Upper limit is maximum speed permissible with flaps extended.
Green Band	41 - 124	Normal Operating Range. Lower limit is maximum weight V_{S1} at most forward C.G. with flaps retracted. Upper limit is maximum structural cruising speed.
Yellow Band	124 - 148	Operations must be conducted with caution and only in smooth air.
Red Line	≥ 149	Maximum speed for all operations.
Flaps 25° Tick Mark	85	Maximum Flaps 25° Operation
Flaps 10° Tick Mark	100	Maximum Flaps 10° Operation
Vx Tick Mark	57	Best Angle of Climb Air Speed
Vy Tick Mark	62	Best Rate of Climb Air Speed

Figure 9-1

POWERPLANT AND ELECTRICAL INSTRUMENT MARKINGS

Powerplant and electrical instrument markings and their color code significance are shown in Figure 9-3. Operation with indications in the red range is prohibited. Avoid operating with indicators in the yellow range.

POWERPLANT AND ELECTRICAL INSTRUMENT MARKINGS

INSTRUMENT	RED (LOWER WARNING)	YELLOW (LOWER CAUTION)	GREEN (NORMAL OPERATING RANGE)	YELLOW (UPPER CAUTION)	RED (UPPER WARNING)
Tachometer (RPM)	----	----	2000 to 2750 RPM		2750* to 3500 RPM
Oil Temperature (OIL °F)	----	0 to 75°F	75 to 220°F	220 to 240°F	240* to 265°F
Oil Pressure (OIL PSI)	0 to 10 PSI	10 to 30 PSI	30 to 60 PSI	60 to 100 PSI	100* to 140 PSI
Exhaust Gas Temperature (if installed) (EGT °F)	----	----	1000 to 1600°F White Advisory		
Carburetor Temperature (CARB °F)		5 to 40°F			
Battery Current (AMPS)			-35 to 35 White Advisory		
Bus Voltage (VOLTS)	-30 to 12.5		12.5 to 15	15 to 16	16 to 30

*Maximum operating limit is lower end of red.

Figure 9-2

PLACARDS

The following information must be displayed in the form of composite or individual placards.

1. In full view of the pilot: (The DAY-NIGHT-VFR entry, shown on the example below, will vary with installed equipment):

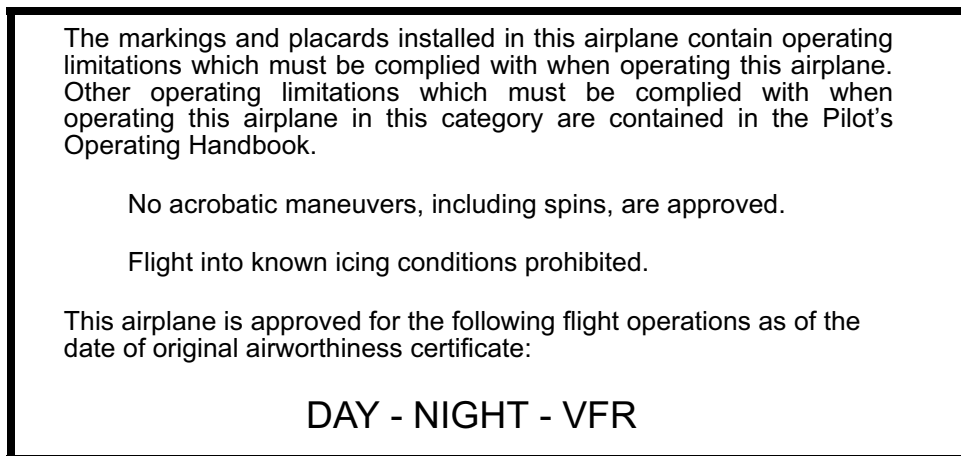

2. On control lock:

B6143

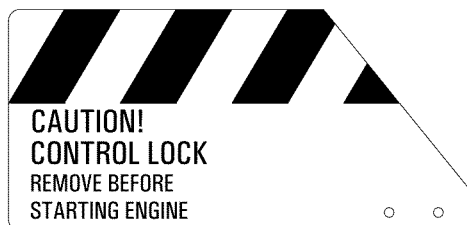

3. Silk-screened on left instrument panel above magnetos switch:

TAKEOFF PROHIBITED WITH LESS THAN 1/4 FUEL $\frac{\text{MIN}}{\text{TO}}$

(Continued Next Page)

PLACARDS (Continued)

4. Silk-screened on the lower left instrument panel:

WARNING

Assure that all contaminants, including water, are removed from fuel and fuel systems before flight. Failure to assure contaminant free fuel and heed all safety instructions and owner advisories prior to flight can result in bodily injury or death.

5. Silk-screened on the upper left instrument panel:

NO INTENTIONAL SPINS

6. On the instrument panel directly above the PFD:

**MAXIMUM OPERATING MANEUVERING SPEED: 89 KIAS
DESIGN MANEUVERING SPEED: 102 KIAS**

7. Silk-screened on the upper right instrument panel:

B6151

SMOKING PROHIBITED

8. Silk-screened on the right instrument panel:

This aircraft was manufactured in accordance with Light Sport Aircraft airworthiness standards and does not conform to standard category airworthiness requirements.

(Continued Next Page)

PLACARDS (Continued)

9. On the right side of the baggage compartment below the window:

B14615

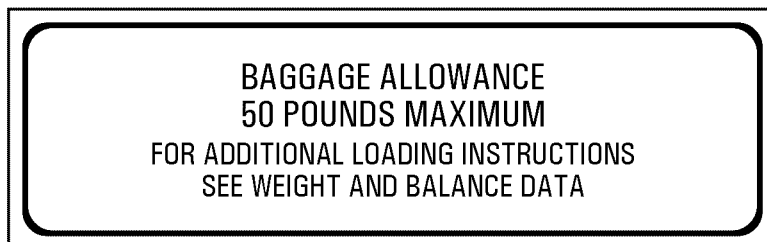

10. Near both fuel tank filler cap:

B14617

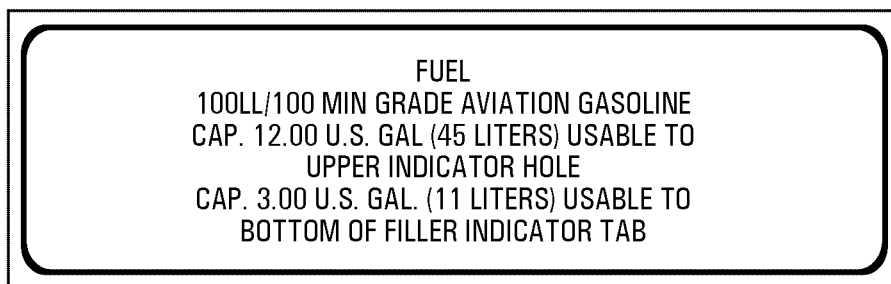

11. On the engine oil access door:

B14541

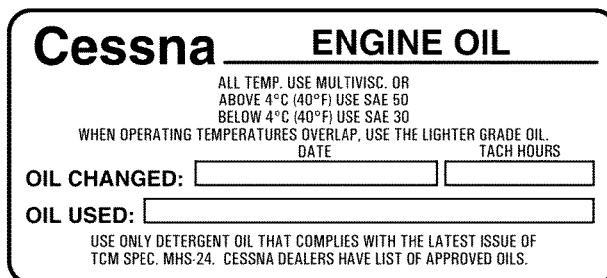

(Continued Next Page)

PLACARDS (Continued)

12. On firewall adjacent to battery box and second placard on external power receptacle door if external power receptacle option is installed:

B14616

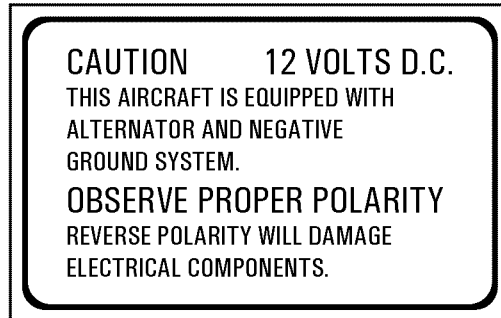

13. Located on both left and right fuel sight tubes:

B14537

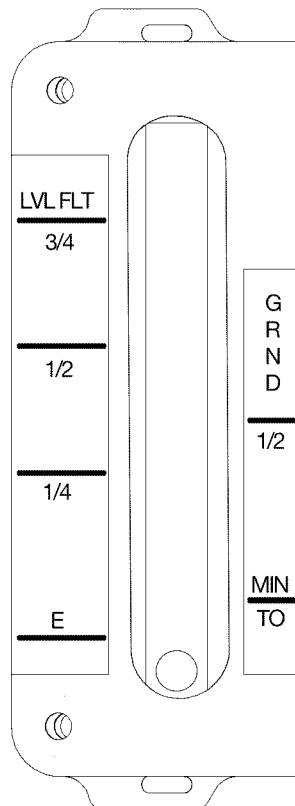

0914T1028

SUPPLEMENTS

INTRODUCTION

The supplements in this section contain amended operating limitations, operating procedures, performance data and other necessary information for airplanes conducting special operations for both standard and optional equipment installed in the airplane. Operators should refer to each supplement to ensure that all limitations and procedures appropriate for their airplane are observed.

A Cessna Approved Log Of Approved Supplements is provided for convenience only. This log is a numerical list of all Cessna Approved supplements applicable to this airplane by name, supplement number and revision level. This log should be used as a checklist to ensure all applicable supplements have been placed in the Pilot's Operating Handbook (POH). Supplements for both standard and installed optional equipment must be maintained to the latest revision. Those supplements applicable to optional equipment which is not installed in the airplane, do not have to be retained.

Each individual supplement contains its own Log of Effective Pages. This log lists the page number and revision level of every page in the supplement. The log also lists the dates on which revisions to the supplement occurred. Supplement page numbers will include an S and the supplement number preceding the page number.

The part number of the supplement provides information on the revision level. Refer to the following example:

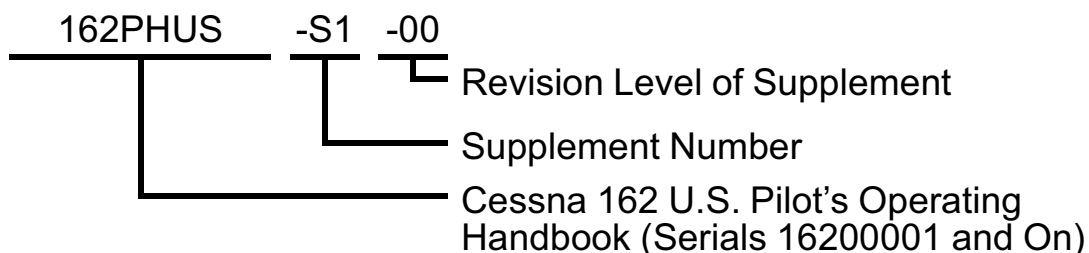

LOG OF APPROVED SUPPLEMENTS

NOTE

It is the airplane owner's responsibility to make sure that he or she has the latest revision to each supplement of a Pilot's Operating Handbook, and the latest issued "Log Of Approved Supplements". This "Log Of Approved Supplements" was the latest version as of the date it was shipped by Cessna; however, some changes may have occurred, and the owner should verify this is the latest, most up-to-date version by contacting Cessna Customer Service at (316) 517-5800.

Supplement Number	Name	Revision Level	Equipment Installed
1	Ameri-King AK-450 Emergency Locator Transmitter (ELT)	0	_____
2	Ameri-King AK-451 Emergency Locator Transmitter (ELT)	0	_____
3	PS Engineering PM3000 Intercom System	0	_____
4	Reserved		_____
5	Reserved		_____
6	Garmin GTX 327 Transponder	0	_____
7	Garmin SL 40 VHF Comm Transceiver	0	_____

Pilot's Operating Handbook And Flight Training Supplement

SKYCATCHER

CESSNA MODEL 162

Serials 1620001 and On

SUPPLEMENT 1

AMERI-KING AK-450 EMERGENCY LOCATOR TRANSMITTER (ELT)

SERIAL NO. _____

REGISTRATION NO. _____

This supplement must be inserted into Section 10 of the Pilot's Operating Handbook and Airplane Flight Manual when the Ameri-King AK-450 Emergency Locator Transmitter (ELT) is installed.



Member of GAMA

COPYRIGHT © 2009
CESSNA AIRCRAFT COMPANY
WICHITA, KANSAS, USA

2 NOVEMBER 2009

SUPPLEMENT 1

AMERI-KING AK-450 EMERGENCY LOCATOR TRANSMITTER (ELT)

Use the Log of Effective Pages to determine the current status of this supplement.

Pages affected by the current revision are indicated by an asterisk (*) preceding the page number.

Supplement Status

Original Issue

Date

2 November 2009

LOG OF EFFECTIVE PAGES

Page Number	Page Status	Revision Number
S1-1 thru S1-8	Original	0

SERVICE BULLETIN CONFIGURATION LIST

The following is a list of Service Bulletins that are applicable to the operation of the airplane, and have been incorporated into this supplement. This list contains only those Service Bulletins that are currently active.

<u>Number</u>	<u>Title</u>	<u>Airplane Serial</u>	<u>Revision</u>	<u>Incorporated</u>
		<u>Effectivity</u>	<u>Incorporated</u>	<u>in Airplane</u>

AMERI-KING AK-450 EMERGENCY LOCATOR TRANSMITTER (ELT)

GENERAL

The Ameri-King AK-450 Emergency Locator Transmitter (ELT) installation uses a solid-state 2-frequency transmitter, 121.5 and 243.0 MHz, powered by six "D" cell alkaline batteries (Duracell MN 1300 or manufactures' approved equivalent). The AK-450 is also equipped with an panel-mounted remote switch assembly and an external antenna mounted on the top of the tailcone. The remote switch assembly is installed on the right instrument panel and receives power from a single lithium cell battery (Duracell DL1/3 NB or manufactures' approved equivalent).

CAUTION

**USE OF NON-APPROVED BATTERIES WILL VOID
MANUFACTURERS' TSO-91A AND PRODUCT
WARRANTIES.**

The remote switch controls ELT operating modes from the flight crew station. When the ELT main unit control switch is set to the ARM position, the transmitter is energized only when the internal "G" switch senses longitudinal inertia forces per TSO-C91a/TSO-C126. In emergency situations the transmitter can also be immediately energized by pressing the ON switch located within the remote switch assembly.

The AK-450 transmitter unit is located in the tailcone behind the baggage area. On the ELT transmitter unit is a panel containing an ON/OFF/ARM switch and a transmitter warning light.

The ELT installation uses two different warnings to tell the pilot when the ELT is energized. The aural warning is an unusual sound that is easily heard by the pilot. The visual warning is a steady RED light located within the panel-mounted remote switch that shows the pilot that the ELT has been activated.

When the AK-450 is energized, the ELT transmits the standard swept tone signal on the international VHF frequency of 121.5 MHz and UHF frequency of 243.0 MHz until battery power is gone. The 121.5 MHz signal is mainly used to pinpoint the beacon during search and rescue operations, and is monitored by general aviation, commercial aircraft, and government agencies.

(Continued Next Page)

AMERI-KING AK-450 ELT MAIN CONTROL PANEL

B14687

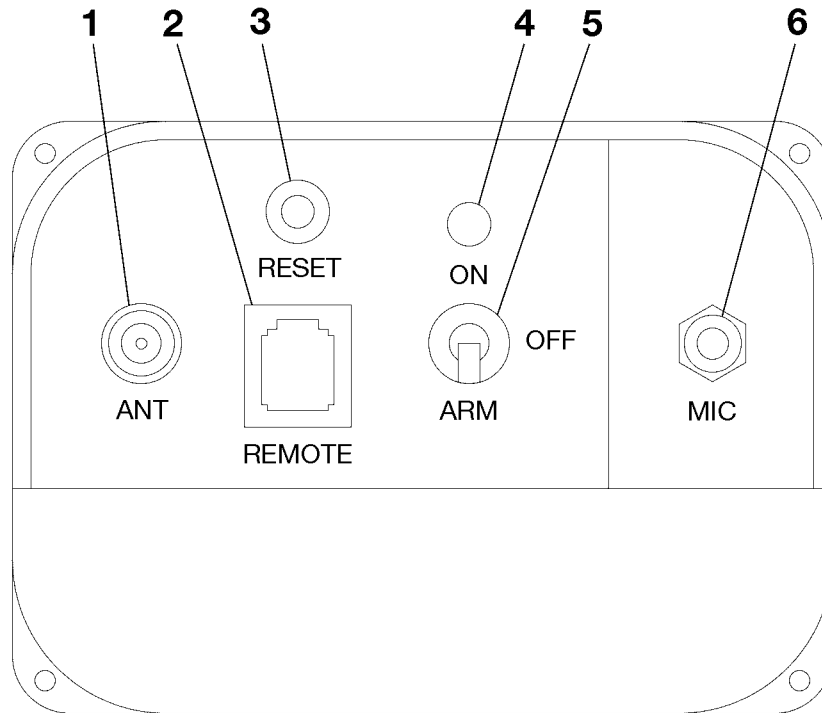

0918T1027

1. ANT - Antenna receptacle connects to the antenna mounted on top of tailcone.
2. REMOTE - Remote cable jack connects to the ELT remote switch assembly located on the upper right instrument panel.
3. RESET - Reset button deactivates transmitter.
4. TRANSMITTER WARNING LIGHT - Light comes on RED to indicate the transmitter is transmitting a distress signal.
5. ELT PANEL SWITCH (3-Position Toggle Switch):
 - a. ON - Activates transmitter instantly. The ON position bypasses the automatic activation switch. The RED warning light on ELT main control panel and the remote panel-mounted switch assembly will come on and aural warning will sound.
 - b. OFF - Turns OFF transmitter for handling, following rescue and to reset the automatic activation function if unable to reset using the remote panel-mounted reset button.
 - c. ARM - ARMS transmitter for automatic activation if “G” switch senses a predetermined deceleration level.

AMERI-KING AK-450 ELT REMOTE SWITCH PANEL

B14688

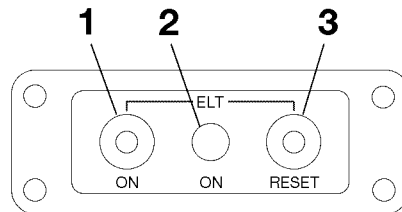

0918T1029

1. ON Button - Remotely activates the transmitter for testing or emergency situations. The RED warning light comes on to indicate that the transmitter is transmitting a distress signal.
2. ON Light - Transmitter warning light comes on RED to indicate the transmitter is transmitting a distress signal.
3. RESET - Reset button deactivates or de-energizes the transmitter.

OPERATING LIMITATIONS

There are no additional airplane operating limitations when the Ameri-King AK-450 ELT is installed.

Refer to 14 CFR 91.207 for ELT inspection requirements. The AK-450 must be inspected and tested by an approved technician using the correct test equipment under the appropriate civil aviation authorities approved conditions.

EMERGENCY PROCEDURES

If a forced landing is necessary, press the ON switch within the remote switch panel before landing. This is very important in remote or mountainous terrain. The RED warning light will illuminate and the aural warning will be heard.

After a landing when search and rescue aid is needed, use the ELT as follows:

NOTE

The ELT remote switch assembly could be inoperative if damaged during a forced landing. If inoperative, the inertia "G" switch will activate automatically. However, to turn the ELT OFF and ON again requires manual switching of the ELT main control panel switch which is located on the ELT transmitter unit located in the tailcone.

1. MAKE SURE THE ELT IS ENERGIZED:
 - a. If the RED warning light in the remote switch panel is not illuminated, press the ON switch within the remote switch panel to energize the ELT transmitter.
 - b. Listen for the aural warning. If the COM radio(s) operate and can be energized safely (no threat of fire or explosion), energize a COM radio and set the frequency to 121.5 MHz. The ELT tone should be heard on the COM radio if the ELT is working correctly. When done, de-energize the COM radio(s) to conserve the airplane battery power.
 - c. Make sure that nothing is touching or blocking the ELT antenna.
2. AFTER RESCUE - Press the RESET button in the remote switch panel to de-energize the ELT. If the remote switch does not de-energize the ELT, press the RESET button on the ELT main control panel located in the tailcone.

NORMAL PROCEDURES

When operating in a remote area or over hazardous terrain, it is recommended that the ELT be inspected by an approved technician more frequently than required by 14 CFR 91.207.

NORMAL OPERATION

Normal operation of the AK-450 ELT from the flight crew station is only to de-energize and arm the ELT after it has been accidentally energized (no emergency).

For normal operation of the AK-450ELT, the main switch on the ELT main control panel must be set to the ARM position. You cannot disarm or disable the ELT transmitter from the cockpit; you can only deactivate the ELT after it has been activated.

The ELT can be energized by a lightning strike or hard landing. If the RED light, within the remote switch panel, is illuminated and the aural warning is heard, the ELT is energized. Check for the emergency signal on a COM radio set to 121.5 MHz. To stop the transmissions, press the RESET button on the remote switch panel to de-energize the ELT. Tell the nearest Air Traffic Control facility about the accidental transmissions as soon as possible to hold search and rescue work to a minimum.

PERFORMANCE

There is no change to the airplane performance when the Ameri-King AK-450 ELT is installed.

Pilot's Operating Handbook And Flight Training Supplement

SKYCATCHER

CESSNA MODEL 162

Serials 1620001 and On

SUPPLEMENT 2

AMERI-KING AK-451 EMERGENCY LOCATOR TRANSMITTER (ELT)

SERIAL NO. _____
REGISTRATION NO. _____

This supplement must be inserted into Section 10 of the Pilot's Operating Handbook and Airplane Flight Manual when the Ameri-King AK-451 Emergency Locator Transmitter (ELT) is installed.



Member of GAMA

COPYRIGHT © 2009
CESSNA AIRCRAFT COMPANY
WICHITA, KANSAS, USA

19 NOVEMBER 2009

SUPPLEMENT 2

AMERI-KING AK-451 EMERGENCY LOCATOR TRANSMITTER (ELT)

Use the Log of Effective Pages to determine the current status of this supplement.

Pages affected by the current revision are indicated by an asterisk (*) preceding the page number.

<u>Supplement Status</u>	<u>Date</u>
Original Issue	19 November 2009

LOG OF EFFECTIVE PAGES

Page Number	Page Status	Revision Number
S2-1 thru S2-9/S2-10	Original	0

SERVICE BULLETIN CONFIGURATION LIST

The following is a list of Service Bulletins that are applicable to the operation of the airplane, and have been incorporated into this supplement. This list contains only those Service Bulletins that are currently active.

<u>Number</u>	<u>Title</u>	<u>Airplane Serial</u>	<u>Revision</u>	<u>Incorporated</u>
		<u>Effectivity</u>	<u>Incorporated</u>	<u>in Airplane</u>

AMERI-KING AK-451 EMERGENCY LOCATOR TRANSMITTER (ELT)

GENERAL

The Ameri-King AK-451 Emergency Locator Transmitter (ELT) installation uses a solid-state 3-frequency transmitter, 121.5, 243.0 and 406.0 MHz, powered by an internal lithium battery. The AK-451 is also equipped with a panel-mounted remote switch assembly and an external antenna mounted on the top of the tailcone. The remote switch assembly is installed on the right instrument panel and receives power from a single lithium cell battery (Duracell DL1/3 NB or manufactures' approved equivalent).

CAUTION

**USE OF NON-APPROVED BATTERIES WILL VOID
MANUFACTURERS' TSO-91A AND PRODUCT
WARRANTIES.**

The remote switch controls ELT operating modes from the flight crew station. When the ELT main unit control switch is set to the ARM position, the transmitter is energized only when the internal "G" switch senses longitudinal inertia forces per TSO-C91a/TSO-C126. In emergency situations the transmitter can also be immediately energized by pressing the ON switch located within the remote switch assembly.

The AK-451 transmitter unit is located in the tailcone behind the baggage area. On the ELT transmitter unit is a panel containing an ON/OFF/ARM switch and a transmitter ON light.

The ELT installation uses two different warnings to tell the pilot when the ELT is energized. The aural warning is an unusual sound that is easily heard by the pilot. The visual warning is a flashing GREEN ON light located within the panel-mounted remote switch that shows the pilot that the ELT has been activated.

(Continued Next Page)

GENERAL (Continued)

When the AK-451 is energized, the ELT transmits the standard swept tone signal on the international VHF frequency of 121.5 MHz and UHF frequency of 243.0 MHz until battery power is gone. The 121.5 MHz signal is mainly used to pinpoint the beacon during search and rescue operations, and is monitored by general aviation, commercial aircraft, and government agencies.

In addition, for the first 24 hours of the ELT being energized, a 406.028 MHz signal is transmitted at 50 second intervals. This transmission lasts 520 milliseconds and contains identification data programmed into the ELT and is received by COSPAS/SARSAT satellites. The transmitted data may include the Aircraft ID, ELT Serial Number, Country Code, and COSPAS/SARSAT ID.

GENERAL (Continued)

AMERI-KING AK-451 ELT MAIN CONTROL PANEL

B14857

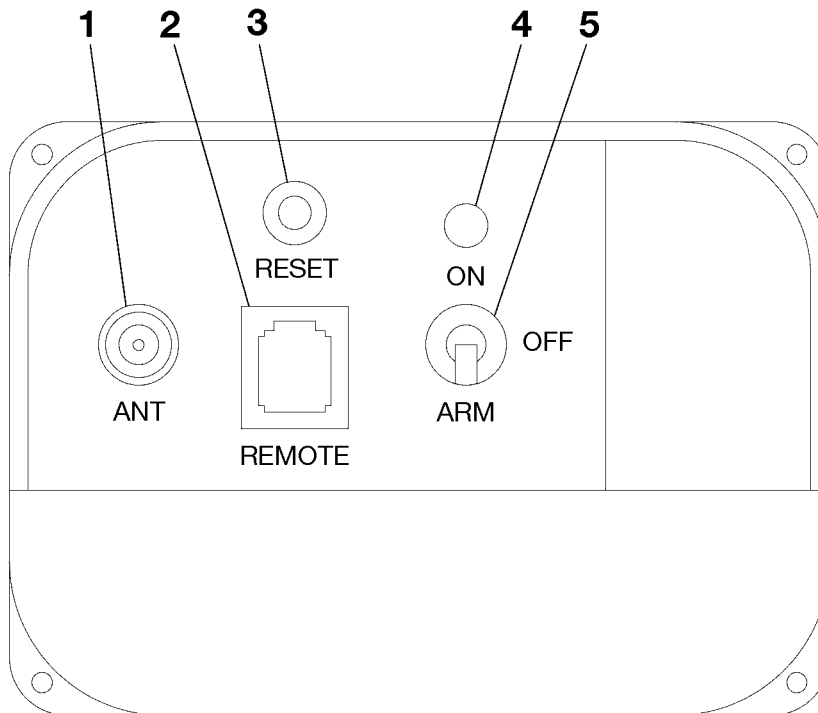

0918T1027

1. ANT - Antenna receptacle connects to the antenna mounted on top of tailcone.
2. REMOTE - Remote cable jack connects to the ELT remote switch assembly located on the upper right instrument panel.
3. RESET - Reset button deactivates transmitter.
4. TRANSMITTER ON LIGHT - Light flashes GREEN to indicate the transmitter is transmitting a distress signal.
5. ELT PANEL SWITCH (3-Position Toggle Switch):
 - a. ON - Activates transmitter instantly. The ON position bypasses the automatic activation switch. The GREEN ON light on ELT main control panel and the remote panel-mounted switch assembly will flash and aural warning will sound, at a rate of 1 second ON, 4 seconds OFF.
 - b. OFF - Turns OFF transmitter for handling, following rescue and to reset the automatic activation function if unable to reset using the remote panel-mounted reset button.
 - c. ARM - ARMS transmitter for automatic activation if "G" switch senses a predetermined deceleration level.

GENERAL (Continued)

AMERI-KING AK-451 ELT REMOTE SWITCH PANEL

B14668

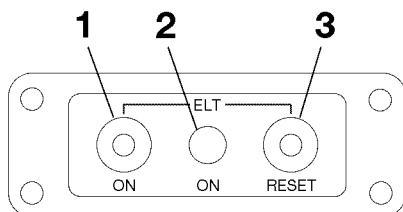

0918T1029

1. ON Button - Remotely activates the transmitter for testing or emergency situations. The GREEN ON light flashes to indicate the ELT transmitter is transmitting a distress signal.
2. ON Light - Transmitter ON light flashes GREEN to indicate the transmitter is transmitting a distress signal.
3. RESET - Reset button deactivates or de-energizes the transmitter.

OPERATING LIMITATIONS

There are no additional airplane operating limitations when the Ameri-King AK-451 ELT is installed.

The airplane owner or operator must register the AK-451 ELT with the applicable civil aviation authority before use to make sure that the identification code transmitted by the ELT is in the COSPAS/SARSAT database. Refer to www.cospas-sarsat.org for registration information.

Refer to 14 CFR 91.207 for ELT inspection requirements. The AK-451 must be inspected and tested by an approved technician using the correct test equipment under the appropriate civil aviation authorities approved conditions.

EMERGENCY PROCEDURES

If a forced landing is necessary, press the ON switch within the remote switch panel before landing. This is very important in remote or mountainous terrain. The GREEN ON light will flash and the aural warning will be heard.

After a landing when search and rescue aid is needed, use the ELT as follows:

NOTE

The ELT remote switch assembly could be inoperative if damaged during a forced landing. If inoperative, the inertia "G" switch will activate automatically. However, to turn the ELT OFF and ON again requires manual switching of the ELT main control panel switch which is located on the ELT transmitter unit located in the tailcone.

1. MAKE SURE THE ELT IS ENERGIZED:
 - a. If the GREEN ON light in the remote switch panel is not flashing, press the ON switch within the remote switch panel to energize the ELT transmitter.
 - b. Listen for the aural warning. If the COM radio(s) operate and can be energized safely (no threat of fire or explosion), energize a COM radio and set the frequency to 121.5 MHz. The ELT tone should be heard on the COM radio if the ELT is working correctly. When done, de-energize the COM radio(s) to conserve the airplane battery power.
 - c. Make sure that nothing is touching or blocking the ELT antenna.
2. AFTER RESCUE - Press the RESET button in the remote switch panel to de-energize the ELT. If the remote switch does not de-energize the ELT, press the RESET button on the ELT main control panel located in the tailcone.

NORMAL PROCEDURES

When operating in a remote area or over hazardous terrain, it is recommended that the ELT be inspected by an approved technician more frequently than required by 14 CFR 91.207.

NORMAL OPERATION

Normal operation of the AK-451 ELT from the flight crew station is only to de-energize the ELT after it has been accidentally energized (no emergency).

For normal operation of the AK-451 ELT, the main switch on the ELT main control panel must be set to the ARM position. You cannot disarm or disable the ELT transmitter from the cockpit; you can only deactivate the ELT after it has been activated.

The ELT can be energized by a lightning strike or hard landing. If the GREEN ON light, within the remote switch panel, is flashing and the aural warning is heard, the ELT is energized. Check for the emergency signal on a COM radio set to 121.5 MHz. To stop the transmissions, press the RESET button on the remote switch panel to de-energize the ELT. Tell the nearest Air Traffic Control facility about the accidental transmissions as soon as possible to hold search and rescue work to a minimum.

PERFORMANCE

There is no change to the airplane performance when the Ameri-King AK-451 ELT is installed.

Pilot's Operating Handbook And Flight Training Supplement

SKYCATCHER

CESSNA MODEL 162

Serials 1620001 and On

SUPPLEMENT 3

PS ENGINEERING PM3000 INTERCOM SYSTEM

SERIAL NO. _____

REGISTRATION NO. _____

This supplement must be inserted into Section 10 of the Pilot's Operating Handbook and Airplane Flight Manual when the PS Engineering PM3000 Intercom System is installed.



Member of GAMA

COPYRIGHT © 2009
CESSNA AIRCRAFT COMPANY
WICHITA, KANSAS, USA

19 NOVEMBER 2009

SUPPLEMENT 3

PS ENGINEERING PM3000 INTERCOM SYSTEM

Use the Log of Effective Pages to determine the current status of this supplement.

Pages affected by the current revision are indicated by an asterisk (*) preceding the page number.

<u>Supplement Status</u>	<u>Date</u>
Original Issue	19 November 2009

LOG OF EFFECTIVE PAGES

Page Number	Page Status	Revision Number
S3-1 thru S3-10	Original	0

SERVICE BULLETIN CONFIGURATION LIST

The following is a list of Service Bulletins that are applicable to the operation of the airplane, and have been incorporated into this supplement. This list contains only those Service Bulletins that are currently active.

<u>Number</u>	<u>Title</u>	<u>Airplane Serial</u>	<u>Revision</u>	<u>Incorporated</u>
		<u>Effectivity</u>	<u>Incorporated</u>	<u>in Airplane</u>

PS ENGINEERING PM3000 INTERCOM SYSTEM

GENERAL

The PM3000 is a 2-place panel-mounted InterCom System (ICS) allowing voice activated radio communications through the Garmin SL40 VHF Comm radio, conversations between the pilot and copilot and a audio input function connected to the AUX AUDIO INPUT jack or the optional XM radio receiver.

The PM3000 utilizes integrated volume and squelch controls for both pilot and copilot headsets. Both output amplifiers are changed simultaneously whenever an adjustment is made utilizing the VOLUME control knob. Likewise, when an adjustment is made to the SQUELCH control knob, both Voice Activated Squelch (VOX) circuits are changed at the same time. Since the PM3000 ICS is designed to use modern aviation-style stereo headsets, it is not necessary to balance the volume and squelch controls.

The PM3000 has an automatic fail-safe interconnect to the Garmin SL40 VHF Comm radios. If power is disrupted to the PM3000 intercom, for any reason, an internal relay will connect the pilot's headset directly to the SL40 Comm radio allowing uninterrupted radio communications to the pilot's headset only. If there is a power failure of the PM3000 ICS or the power switch is selected to the off position, the copilot will not hear radio communications.

The PM3000 is also equipped with a two-position mode selector switch, located in the center of the control panel, with positions for ISO (Pilot Only) and ALL (Pilot and Copilot). The Isolation Mode (ISO) connects the pilot directly to the SL40 Comm radios when the pilot must have priority to all radio transmissions. With the mode selector switch in the ALL mode, both pilot and copilot have transmit capabilities over the SL40 Comm radios.

(Continued Next Page)

GENERAL (Continued)

The PM3000 only allows the voice of the person who presses the push-to-talk switch (PTT) first to be transmitted over the Comm radios using remote microphones. When either the pilot or copilot presses the PTT switch, the other microphone is disabled. If both pilot and copilot press the PTT switch at the same time, the copilot will override any transmission from the pilot. The pilot can regain priority of radio transmissions by pressing the PM3000 VOLUME control knob to power the intercom off. With the intercom powered off, an internal relay will connect the pilot's headset directly to the SL40 Comm radio allowing uninterrupted radio communications to the pilot's headset only.

AUDIO ENTERTAINMENT

The entertainment input function of the PM3000 ICS allows the pilot and copilot the option of listening to audio files during flight from either the XM radio feed (if installed) or from any entertainment audio device connected to the AUX AUDIO INPUT jack located on the center pedestal. It allows entertainment audio devices such as cassette, compact disc, and MP3 players to play music over the airplane's headsets.

During intercom communication or airplane radio reception, the entertainment audio level will automatically mute to allow communications without distraction. When the communication activity ceases, the circuitry gradually returns the entertainment audio level to the original listening volume.

The optional XM weather and XM radio data link provides weather information and digital audio entertainment in the cockpit through a input on the optional MFD display. A subscription to the XM satellite radio service is required for the XM weather and radio data link to be used. Refer to the Garmin G300 Pilot's Guide for operational instructions for the XM weather and XM radio data link.

NOTE

Audio input from the optional XM radio data link will be disconnected when any audio device is connected to the AUX AUDIO INPUT jack.

(Continued Next Page)

GENERAL (Continued)

AUDIO ENTERTAINMENT (Continued)

Since the entertainment audio input is not controlled by a switch, there is no way to deselect the entertainment source except to disconnect the source at the audio input connector. In the event of a high pilot workload and/or heavy traffic, it is wise to disable the entertainment audio to eliminate a source of distraction for the flight crew.

NOTE

- Passenger briefing should specify that AUX AUDIO INPUT (entertainment audio input) and Portable Electronic Device (PED) use is permitted only during the enroute phase of flight.
- Disconnect the cable from the AUX AUDIO INPUT jack when not in use.
- Use caution with audio cables in the cabin to avoid entangling occupants or cabin furnishings and to prevent damage to cables.

The PM3000 Pilot's Guide & User Manual, publication no. 202-193-0001, or other PS Engineering publications can be obtained by contacting PS Engineering, Inc., 9800 Martel Road, Lenoir City, TN 37772, (865) 988-9800, or visit the PS Engineering website (www.ps-engineering.com) for current updates and supplemental information.

GENERAL (Continued)

**PS ENGINEERING PM3000 INTERCOM SYSTEM
CONTROL PANEL**

B14689

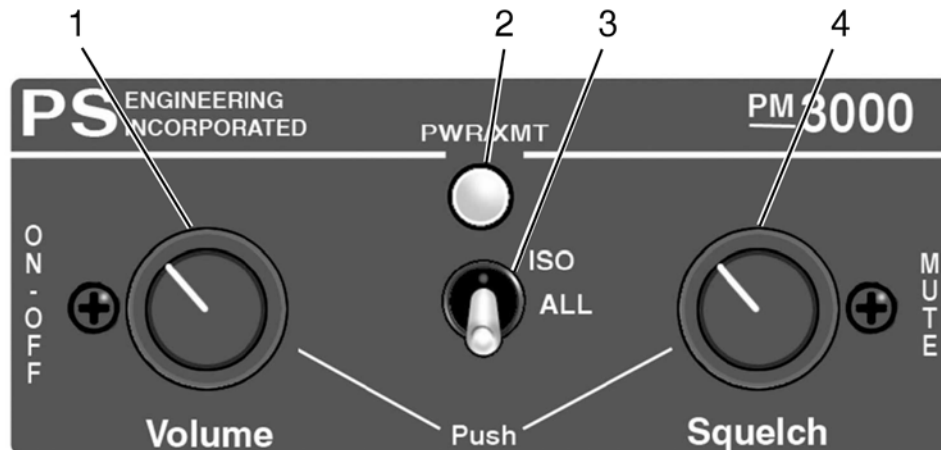

0918G1028

1. Power/Volume Control Knob
 - a. Power ON/OFF - Pressing the VOLUME control knob will power on the unit ON and OFF.
 - b. Volume - Turn the VOLUME control knob clockwise to increase the volume level and counterclockwise to decrease the volume level. The VOLUME control knob adjusts the volume level of the intercom and audio input only and does not affect the volume level of the SL40 Comm radio. This feature allows the airplane radio and intercom volume to be balanced independently.

NOTE

The PM3000 volume level affects the audio level for both the pilot and copilot headsets and will not change with the number of headset connected.

2. PWR/XMT Indicator Light - The fixed intensity LED indicator, located above the mode selector switch, will illuminate green when the unit is powered on. The LED indicator will illuminate red during radio transmissions by either the pilot or copilot. The LED indicator will also illuminate red during a "stuck mic" condition.

(Continued Next Page)

GENERAL (Continued)

PS ENGINEERING PM3000 INTERCOM SYSTEM CONTROL PANEL (Continued)

3. ISO/ALL Mode Selector Switch - The mode selector switch allows the pilot to select the intercom function best suited for the current flight conditions. Regardless of configuration, the pilot will always hear radio communications through the SL40 Comm radio.

NOTE

If power is disrupted to the PM3000 intercom, for any reason, an internal relay will connect the pilot's headset directly to the intercom function of the SL40 Comm radio allowing uninterrupted radio communications to the pilot's headset only.

- a. ISO (Up Position): The pilot is isolated from the intercom and is connected only to the SL40 Comm radios. He will hear the airplane radio reception (and sidetone during radio transmissions). The copilot will hear himself and music but not the airplane radio traffic.
- b. ALL (Down position): Pilot and copilot will hear all radio communications, intercom, and music. However, during any ICS conversation, the music volume automatically mutes. The music volume increases gradually back to the original level after radio communications have been completed.

(Continued Next Page)

GENERAL (Continued)

PS ENGINEERING PM3000 INTERCOM SYSTEM CONTROL PANEL (Continued)

4. SQUELCH Control Knob - Separate squelch circuits for the pilot and copilot are controlled by the single Squelch control knob. Normal speech levels should open the channel when the microphone is positioned properly near the lips. This VOX operated intercom keeps the microphone channels off (silent) when the pilot or copilot is not speaking to reduce the background noise coming from the airplane.

When talking is stopped, a delay of about one half second occurs before the channel closes. Proper setting of the squelch level prevents "squelch closure" between words to eliminate choppy intercom conversations.

- a. SQUELCH Control - Set the squelch level with the engine running by slowly rotating the SQUELCH control knob clockwise until you no longer hear background noise in the headsets.
- b. MUTE Control - Normally, any radio traffic or intercom conversations will automatically mute the audio signal with the mode selector switch in ALL position. However, the PM3000 can be placed in an uninterrupted music mode by activating the mute control circuit. Pressing the SQUELCH control knob once will activate this mode. In this mode, it is possible to have the music remain at a constant level, regardless of any ICS or radio traffic. When music is at a constant level, both music and ICS (intercom and radio) communications will be heard at the same time. Press the MUTE control knob again will restore the music auto-muting function.

NOTE

It is recommended that the MUTE mode (uninterrupted music) not be active when radio communications are being conducted or monitored with any air traffic control facility, ground facility, or other airplane.

OPERATING LIMITATIONS

Headsets are required for audio communications. In the event of pilot and copilot simultaneously pressing the PTT, the copilot will override. If desired, the pilot may regain priority by switching the intercom unit off.

EMERGENCY PROCEDURES

If power is disrupted to the PM3000 intercom, for any reason, an internal relay will connect the pilot's headset directly to the intercom function of the SL40 Comm radio allowing uninterrupted radio communications to the pilot's headset only. If there is a power failure of the PM3000 ICS or the power switch is selected to the off position, the copilot will not hear radio communications. If flight instruction is being given, the instructor in the copilot's seat may desire to retain radio communications. This emergency situation will require the pilot and copilot to swap headsets or switch headset jacks. The pilot's control stick PTT switch will still control all radio transmissions.

NORMAL PROCEDURES

There is no change to the airplane normal procedures when the PS Engineering PM3000 Intercom System is installed.

PERFORMANCE

There is no change to the airplane performance when the PS Engineering PM3000 Intercom System is installed.

Pilot's Operating Handbook And Flight Training Supplement

SKYCATCHER

CESSNA MODEL 162

Serials 1620001 and On

SUPPLEMENT 6

GARMIN GTX 327 TRANSPONDER

SERIAL NO. _____

REGISTRATION NO. _____

This supplement must be inserted into Section 10 of the Pilot's Operating Handbook and Airplane Flight Manual when the Garmin GTX 327 Transponder is installed.



Member of GAMA

COPYRIGHT © 2009
CESSNA AIRCRAFT COMPANY
WICHITA, KANSAS, USA

2 NOVEMBER 2009

SUPPLEMENT 6

GARMIN GTX 327 TRANSPONDER

Use the Log of Effective Pages to determine the current status of this supplement.

Pages affected by the current revision are indicated by an asterisk (*) preceding the page number.

Supplement Status

Original Issue

Date

2 November 2009

LOG OF EFFECTIVE PAGES

Page Number	Page Status	Revision Number
S6-1 thru S6-7/S6-8	Original	0

SERVICE BULLETIN CONFIGURATION LIST

The following is a list of Service Bulletins that are applicable to the operation of the airplane, and have been incorporated into this supplement. This list contains only those Service Bulletins that are currently active.

<u>Number</u>	<u>Title</u>	<u>Airplane Serial</u> <u>Effectivity</u>	<u>Revision</u> <u>Incorporated</u>	<u>Incorporated</u> <u>in Airplane</u>
---------------	--------------	--	--	---

GARMIN GTX 327 TRANSPONDER

GENERAL

The Garmin GTX 327 Transponder is capable of both Mode A and Mode C operations. In addition to altitude and location reporting functions, the GTX 327 also provides a pressure altitude display with trend indications, a flight time display, a count up timer, and a count down timer.

OPERATING LIMITATIONS

There is no change to the airplane operating limitations when the Garmin GTX 327 Transponder is installed.

EMERGENCY PROCEDURES

There is no change to the airplane emergency procedures when the Garmin GTX 327 Transponder is installed. Refer to current FAR/AIM procedures for emergency codes and transponder inoperative situations.

NORMAL PROCEDURES

GARMIN GTX 327 TRANSPONDER

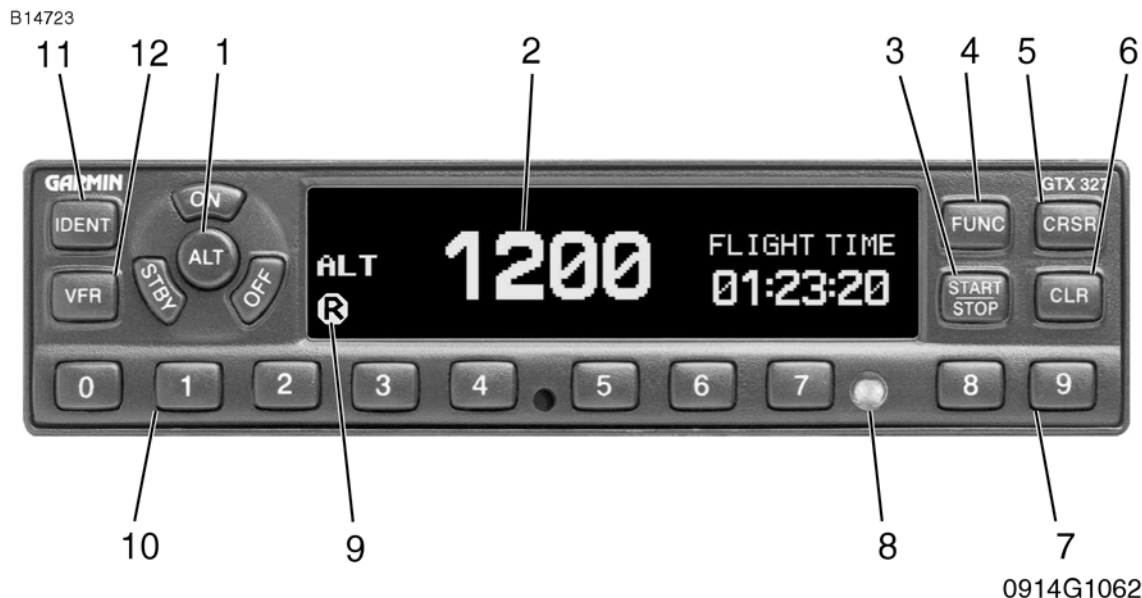

Figure S6-1

1. MODE SELECTION
 - a. OFF - Powers off the GTX 327 transponder.
 - b. STBY - Powers on the GTX 327 transponder displaying the last active identification code, but will not allow a reply to any interrogations.
 - c. ON - Powers on the GTX 327 transponder displaying the last active identification code and selects Mode A operation. Mode A operation replies to any interrogations, as indicated by the Reply Symbol ®, but does not include altitude information.
 - d. ALT - Powers on the GTX 327 transponder displaying the last active identification code and allows for both Mode A and Mode C operations. When operating in the ALT mode, the transponder replies to any identification and altitude interrogations as indicated by the Reply Symbol ®.
2. Display Screen - LED display provides information for all active functions.
3. START/STOP - Starts and stops the Count Up, Count Down and Flight timers.

(Continued Next Page)

NORMAL PROCEDURES (Continued)

4. FUNC - Multiple presses of the FUNC key changes the function page displayed on the right side of the display screen to one of the following pages:
 - a. PRESSURE ALT - Displays pressure altitude in hundreds of feet.
 - b. FLIGHT TIME - Controlled by the START/STOP key, or can be configured to START when the airplane exceeds 30 KTS GPS ground speed, and STOP when the airplane slows below 30 KTS.
 - c. COUNT UP TIMER - Controlled by the START/STOP key. Use CLR key to reset timer to 0:00.
 - d. COUNT DOWN TIMER - Enter time using numerical keys, and use START/STOP key to activate. Use CLR key to reset timer to 0:00.
5. CRSR - Initiates starting time entry for the Count Down timer and cancels transponder code entry.
6. CLR - Resets the Count Up, Count Down, and Flight timers. Cancels the previous keypress during code selection and Count Down entry. Returns cursor to the fourth code digit within five seconds after entry.
7. Numerical keys 8 and 9 are not used for code entry, only for entering the number 8 or 9 into the count down timer.
8. PHOTOCCELL - Automatically controls the intensity of the display from low brightness at night to high brightness during daylight operations. Display brightness may also be controlled manually using the FUNC key.
9. REPLY INDICATOR - The Reply Symbol ® will blink each time the transponder replies to ground interrogations. The Reply Symbol ® will remain illuminated during the 18 second IDENT time interval.
10. CODE SELECTION - Code selection is accomplished using the numerical keys (0 - 7). Pushing one of these keys begins the code selection sequence. The new code will not be active until the fourth digit is entered. Pressing the CLR key will move the cursor back to the previous digit. Pressing the CLR key when the cursor is on the first digit, or pressing the CRSR key at any time will cancel the entry and restore the previous code.

(Continued Next Page)

NORMAL PROCEDURES (Continued)

11. IDENT - Pressing the IDENT key activates the Special Position Identification (SPI) pulse for 18 seconds, identifying the transponder return from others on the air traffic controller's screen. The word "IDENT" will appear in the upper left corner of the display when IDENT mode is active.
12. VFR - Sets the transponder code to 1200 (unless configured otherwise). Pressing the VFR key again will restore the previous identification code.

ALTITUDE TREND INDICATOR

When the PRESSURE ALT page is displayed, an arrow may be displayed to the right of the altitude, indicating that the altitude is increasing or decreasing. Two sizes of arrows may be displayed depending on rate of climb/descent.

AUTOMATIC ALT/STBY MODE SWITCHING

The GTX 327 automatically switches to ALT mode when ground speed exceeds approximately 30 knots GPS ground speed. The unit automatically returns to STBY mode when the airplane slows below 30 knots.

NOTE

The ON (Mode A), ALT (Mode C), and STBY keys can be used at any time to manually override the automatic ALT/STBY mode switching.

PERFORMANCE

There is no change to the airplane performance when the Garmin GTX 327 Transponder is installed.

Pilot's Operating Handbook And Flight Training Supplement

SKYCATCHER

CESSNA MODEL 162

Serials 1620001 and On

SUPPLEMENT 7

GARMIN SL 40 VHF COMM TRANSCEIVER

SERIAL NO. _____

REGISTRATION NO. _____

This supplement must be inserted into Section 10 of the Pilot's Operating Handbook and Airplane Flight Manual when the Garmin SL 40 VHF Comm Transceiver is installed.



Member of GAMA

COPYRIGHT © 2009
CESSNA AIRCRAFT COMPANY
WICHITA, KANSAS, USA

2 NOVEMBER 2009

SUPPLEMENT 7

GARMIN SL 40 VHF COMM TRANSCEIVER

Use the Log of Effective Pages to determine the current status of this supplement.

Pages affected by the current revision are indicated by an asterisk (*) preceding the page number.

Supplement Status

Original Issue

Date

2 November 2009

LOG OF EFFECTIVE PAGES

Page Number	Page Status	Revision Number
S7-1 thru S7-8	Original	0

SERVICE BULLETIN CONFIGURATION LIST

The following is a list of Service Bulletins that are applicable to the operation of the airplane, and have been incorporated into this supplement. This list contains only those Service Bulletins that are currently active.

<u>Number</u>	<u>Title</u>	<u>Airplane Serial</u> <u>Effectivity</u>	<u>Revision</u> <u>Incorporated</u>	<u>Incorporated</u> <u>in Airplane</u>
---------------	--------------	--	--	---

GARMIN SL 40 VHF COMM TRANSCEIVER

GENERAL

The Garmin SL 40 VHF Comm Transceiver consists of a panel-mounted receiver-transmitter, which includes a 760 channel VHF communications receiver-transmitter capable of receiving and transmitting signals between 118.000 and 136.975 MHz with 25 kHz spacing.

Active and standby frequencies, along with operational annunciators, are displayed on a photocell controlled LCD matrix display. Control buttons, including those operating the frequency flip-flop feature, standby frequency monitoring and single-button emergency frequency selection are located under the display panel. An internal intercom is also included as a standard feature of the SL40.

Refer to the Garmin SL40 Pilot's Guide, Garmin P/N 190-00488-00 Rev A or later, for a complete listing of system description and operational information.

Garmin publications can be obtained by contact Garmin Customer Service at Garmin International, Inc, (913) 397-8200, Fax (913) 397-8282, 1200 East 151st Street, Olathe, Kansas 66062, USA or visit the Garmin website (www.Garmin.com) for current updates and supplemental information.

OPERATING LIMITATIONS

Headsets are required for all audio communications. Headsets with microphones or a hand-held microphone is required for all radio transmissions.

Transmitting radio communication utilizing the hand-held microphone will require the operator to depress the push-to-talk button on the hand-held microphone and the push-to-talk (PTT) button on the control stick at the same time while speaking directly into the hand-held microphone.

EMERGENCY PROCEDURES

Pressing the Emergency Channel (EC) button automatically loads the Emergency Channel, 121.500 MHz, as the standby frequency. The monitor function will be automatically enabled. Pressing the Flip/Flop (<- ->) button will load the emergency channel into the active frequency for emergency communications.

In an emergency situation, if the STUCK MIC annunciator message remains illuminated after you have stopped keying the microphone, turn the power control knob to the off position and then turn back on. Cycling the main power control knob will allow a 35 second transmission period prior to experiencing another STUCK MIC condition. Cycling of the SL40 power will be required for all future transmission as long as the STUCK MIC annunciator is illuminated.

NORMAL PROCEDURES

GARMIN SL 40 VHF COMM TRANSCEIVER

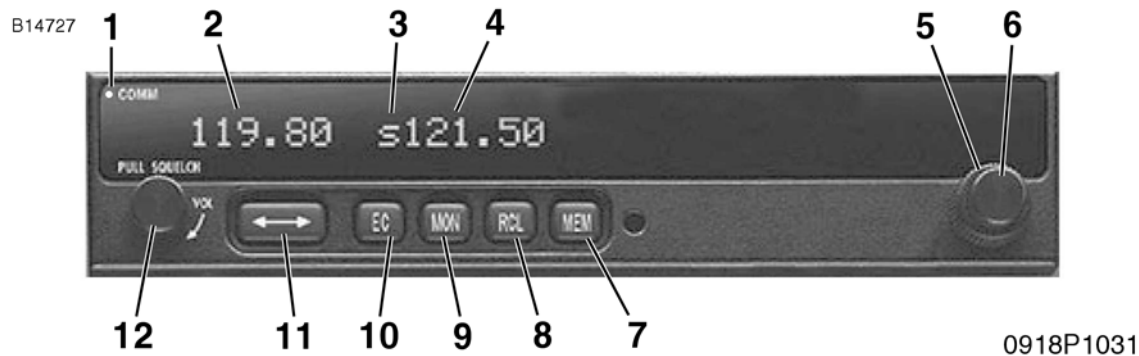

Figure S7-1

1. PHOTO SENSOR - Sensor automatically adjusts display brightness for current lighting conditions. The auto dimming function can be disabled by setting the high display level to zero.
2. ACTIVE FREQUENCY - Displays active communication frequency.
3. ANNUNCIATOR - Displays Transmit (TX), Standby Frequency (s), Monitor (m) and Intercom (I) operational modes.
 - a. Transmit (TX) - A capital "TX" will illuminate whenever the radio is transmitting.
 - b. Standby Frequency (s) - A small "s" will be displayed to the left of the standby frequency display window.
 - c. Monitor Mode (m) - A small "m" will be displayed in front of the standby frequency when the frequency monitoring MON button is selected.
 - d. Intercom (I) - A capital "I" will be displayed when the intercom function is being used.
4. STANDBY FREQUENCY - Displays standby communication frequency.
5. LARGE OUTER KNOB - Rotating the large outer knob will change the standby frequency values in 1 MHz increments and is also used to display available selections within the System Functions mode.
6. SMALL INNER KNOB - Rotating the small inner knob will change the standby frequency values in 25 kHz increments and is also used to make adjustments within the System Functions mode.

(Continued Next Page)

NORMAL PROCEDURES (Continued)

7. MEM - Pressing of the memory button will store the displayed standby frequency into memory. Refer to the Garmin Pilot's Guide for detailed description and operational information.
8. RCL - Pressing the recall memory button will retrieve stored frequency. Refer to the Garmin Pilot's Guide for detailed description and operational information.
9. MON - Pressing of the frequency monitor button will allow monitoring of the standby frequency. A small "m" will be displayed in front of the standby frequency. When the active frequency receives a signal, the unit will switch automatically to the active frequency. An arrow (< or >) will point to the frequency that you are currently listening to.
10. EC - Pressing the emergency channel button automatically loads the Emergency Channel, 121.500 MHz, as the standby frequency. The monitor function will be automatically enabled.
11. Flip/Flop Frequency Control - Pressing the flip/flop button will toggle the standby frequency over to the active frequency.
12. Power/Volume/Squelch Control Knob
 - a. Power ON/OFF - Turning the POWER VOLUME control knob clockwise past the OFF detent will power on the unit.
 - b. Volume - Turn the POWER VOLUME control knob clockwise to increase the volume level and counterclockwise to decrease the volume level.
 - c. Squelch - Pull the POWER VOLUME control knob out to disable the automatic squelch function.

INTERCOM FUNCTION

For airplanes not equipped with the optional PM3000 Intercom, the Garmin SL40 VHF Comm Transceiver is configured to function as a voice-activated intercom system when two headsets and microphones are properly connected.

STUCK MICROPHONE

The Garmin SL40 helps protect the pilot from a situation where the microphone may become stuck in the ON or transmit position. If the microphone is keyed, or activated, for longer than 35 seconds, the SL40 will return to the receive mode on the selected frequency. A flashing "STUCK MIC" message will be displayed until the transmit key is released.

PERFORMANCE

There is no change to the airplane performance when the Garmin SL 40 VHF Comm Transceiver is installed.